

CE Note: **GB**
Within the framework of the CE approval symbol, correct exposure was evaluated in the course of the electromagnetic compatibility test.

⚠ Do not touch the SCA contacts !
In exceptional cases the unit can be damaged if these contacts are touched.



MECABLITZ 40 MZ-1i

Operating Instructions



100% Recyclingpapier

METZ-Werke GmbH & Co KG
Ritterstraße 5 • 90763 Fürth / Bay.
Telefon (0911) 9706-0 • Fax (0911) 9706-340
Internet: <http://www.metz.de>
E-Mail: Metz.Werke@t-online.de

796 47 0197.A2

GB

Nomenclature

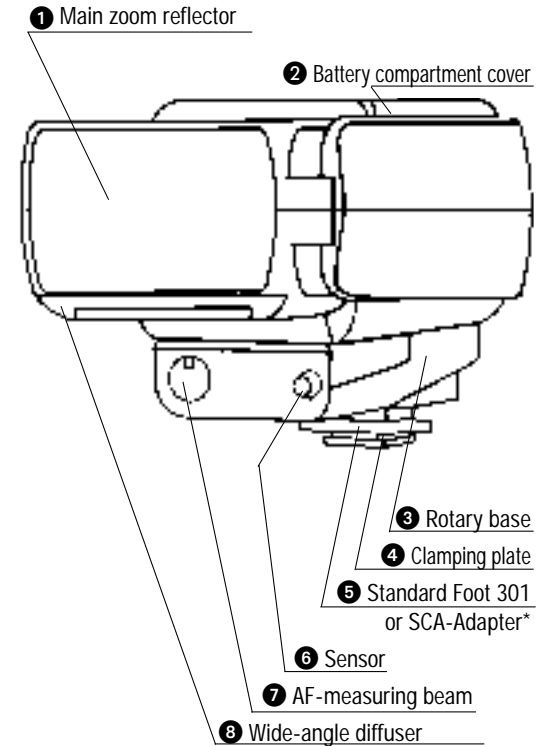
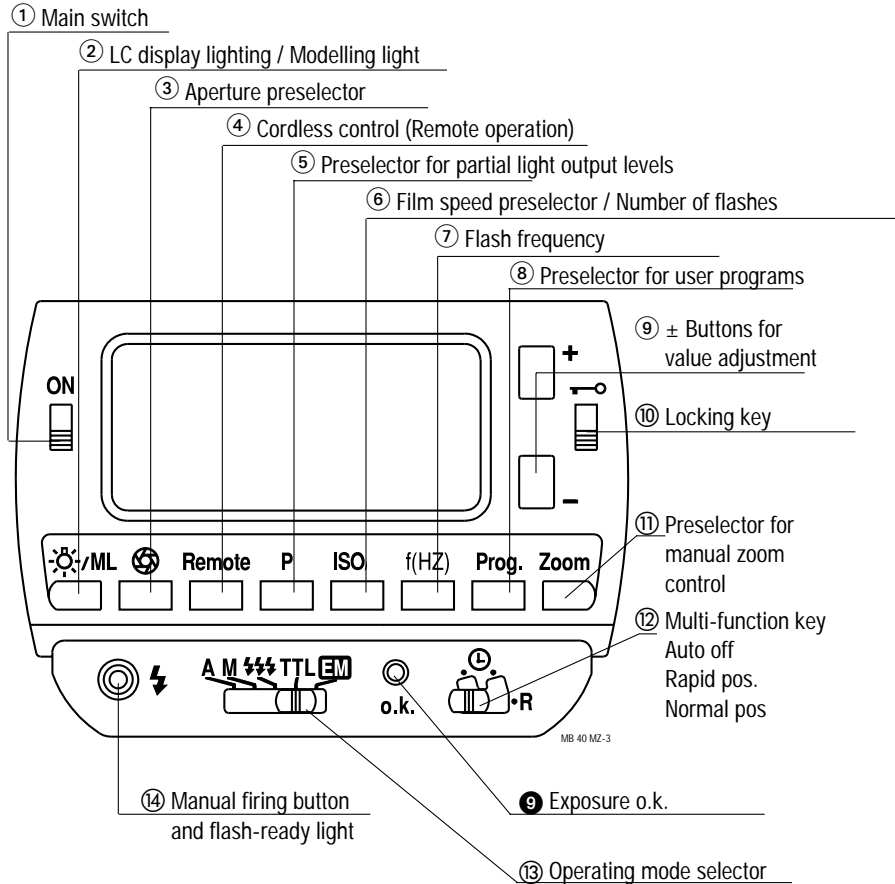

The LC display

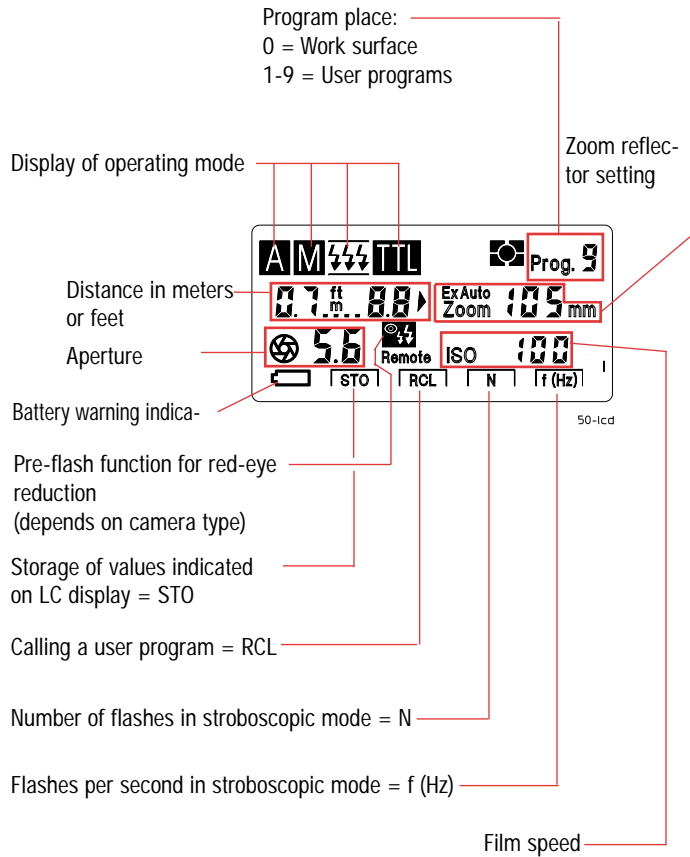

Contents

Foreword	4
1. Safety instructions	6
2. Preparations	7
Suitable batteries	7
Loading and replacing the batteries	8
Battery warning indicator	9
Mounting the mecablitz on the camera	10
Switching the mecablitz on and off	11
3. TTL flash mode	12
TTL Easy-Mode	14
4. Automatic flash mode	15
5. Manual flash mode	18
6. Bounce flash	20
in auto and TTL modes	22
in manual mode	22
7. Metz cordless TTL remote operation	23
Metz cordless auto remote operation	27
8. Winder mode	30
Using the winder in the manual mode	30
Using the winder in auto and TTL modes	30
9. Working with partial light output levels	31
Partial light output levels in the auto mode	31
Partial light output levels in the manual mode	31
Flash durations	33
Macrophotography (close-ups)	33
10. Stroboscopic mode	34

Contents

11. Fill-in flash in daylight	37
Fill-in flash in auto mode	37
Fill-in flash in manual mode	38
Fill-in flash in TTL mode	39
12. Working with user programs	40
Calling a user program	41
Storing a program	42
13. The zoom reflector	43
The Ex-Zoom mode (extended zoom)	44
Wide angle diffuser	45
14. Special functions	46
Correct exposure indicator „o.k.“	46
AF measuring beam	47
The Rapid function	48
The ML function (Modelling Light)	48
Locking the controls	59
Automatic cut-out	50
m - ft display	51
15. Exposure corrections	52
Exposure corrections in auto mode	52
Exposure corrections in TTL mode	52
16. Technical data	54
17. Optional extras	60
18. Troubleshooting hints	62
Alphabetical index	64

Foreword

Congratulations on purchasing this Metz flashgun, and thank you for your confidence in Metz equipment.

It is only natural that you should want to use your flashgun straight away. However, it will be well worth your while to study these Operating Instructions beforehand to ensure that you can operate the flashgun effectively and without any problems.

Please also open the back cover page with the illustrations.

This flashgun can be used with:

- All cameras with a hot shoe contact
- All cameras with accessory shoe without hot-shoe contact, and with a synch cable (see Optional Extras)
- System cameras

Optimal adaptation to your camera is achieved by using an SCA adapter. The enclosed SCA 300/3000 table will indicate the adapter you require for your particular camera model. This table also informs you about the special flash functions that can then be completed by the given system.

Brief survey of the operating functions:

Configuration

Possible operating modes

- | | |
|--|---|
| • 40 MZ-1(i) with
301 standard foot | Automatic flash mode, ch. 4, p. 15
Manual flash mode, ch. 5, p. 18
Metz automatic remote operation, ch. 7.1, p. 27
Stroboscopic mode, ch. 10, p. 34 |
| • 40 MZ-1(i) with
SCA 300 adapter | Automatic flash mode, ch. 4, p. 15
TTL flash mode*, ch. 3, p. 12
TTL Easy Mode*, ch. 3, p. 14
Manual flash mode, ch. 5, p. 18
Metz TTL remote operation*, ch. 7.1, p. 23
Metz automatic remote mode, ch. 7.1., p. 27
Stroboscopic mode, ch. 10, p. 34 |

* If the camera supports this function.

Foreword

- | | |
|---------------------------------------|--|
| • 40 MZ-1(i) with
SCA 3000-adapter | Automatic flash mode, ch. 4, p. 15
TTL flash mode*, ch. 3, p. 12
TTL Easy Mode*, ch. 3, p. 14
Manual flash mode, ch. 5, p. 18
Metz TTL remote mode*, ch. 7, p. 23
Metz automatic remote mode, ch. 7.1., p. 27
Stroboscopic mode, ch. 10, p. 34 |
|---------------------------------------|--|

* If the camera supports this function.

The SCA 3000 adapter is the most convenient link to your camera! The ISO, zoom and aperture data are transmitted, depending upon the camera configuration!

General operating instructions

The subsequent instructions are of a general nature. The procedures identified by red numbers must be completed when using a system camera in conjunction with an SCA 3000 adapter.

All steps identified with an asterisk * must be additionally adjusted, depending upon the given type of camera.

The flashgun is suitable for APS cameras that feature an accessory shoe with hot shoe contact.

In conjunction with the Canon SCA adapter 3101-M3, this flashgun permits Canon E-TTL operating.

1. Safety Instructions

- ⚠ Never fire a flash in the immediate vicinity of the eyes!
Flash fired directly in front of the eyes of a person or animal can damage the retina and lead to severe visual disorders - even blindness!
- ⚠ Exhausted batteries should be immediately removed from the flashgun!
Lye leaking out of dead batteries will damage the flash unit.
- ⚠ Never recharge dry-cell batteries such as alkaline manganese and lithium batteries!
- ⚠ Never short-circuit rechargeable batteries!
- ⚠ Do not expose batteries to excessive heat, for instance sunshine, fire and the like!
- ⚠ Never throw exhausted batteries on a fire!
- ⚠ Do not expose the flashgun to dripping and splashing water!
Protect the flashgun against excessive heat and humidity! Do not store the flashgun in the glove compartment of a car!
- ⚠ Make sure to tighten the knurled screw firmly so that the flashgun cannot slip off!
- ⚠ When taking a sequence of pictures at full light output and fast recycle times during NiCad battery operation, shooting should be interrupted for at least 3 minutes after every 15 flashes, in order to prevent overloading.
- ⚠ Never place material that is impervious to light in front of, or directly on, the reflector screen. The reflector screen must be perfectly clean when a flash is fired. The high energy of the flash light will burn the material or damage the reflector screen if this is not observed!

2. Preparations

Suitable batteries



Fig. 1: Suitable AA-size batteries

The flashgun can be operated with any of the following batteries:

- 4 NiCad rechargeable batteries, type IEC KR 15/51.
They ensure fast recycling times and are very economical as they can be recharged over and over again.
- 4 nickel metal hydride batteries. They have a much higher capacity than NiCad batteries and have less impact on the environment because they are free from cadmium.
- 4 alkaline-manganese batteries, type IEC LR6.
Maintenance-free power source for moderate requirements.
- 4 lithium batteries, type FR6 L91.
Can be stored for many years with virtually no loss of power, thus making them ideal for occasional use.
- Power Pack P 40 (optional extra)
Provides microprocessor controlled battery monitoring and state-of-charge indication (with discharge function).
- Power Grips G 15/16 (optional extra)
Convert a compact flashgun into a handle-mount unit.

2. Preparations

Loading the batteries

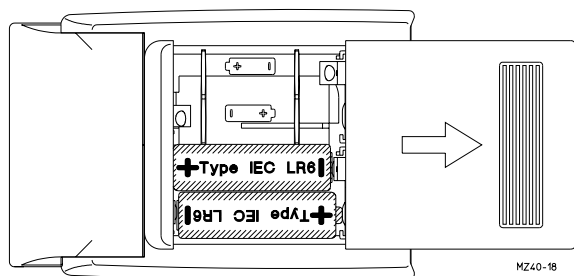

Fig. 2: Position of batteries

Loading and replacing the batteries

- Switch off the flashgun with the main switch ①.
- Push the battery compartment cover ② in direction of the arrow as far as possible.
- Insert the batteries lengthwise into the compartment.
When inserting the batteries ensure that their polarity is correct, as indicated by the symbols in the battery compartment!
- Close the battery compartment cover ②.

☞ **Exhausted batteries must not be thrown into the dustbin! Contribute to the protection of the environment and discard dead batteries at the appropriate disposal points.**

2. Preparations

Battery warning indicator

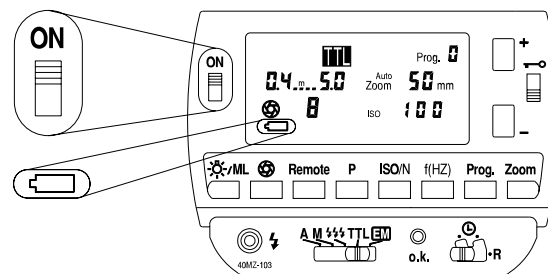

Fig. 3: The battery warning indicator

The battery warning indicator

☞ **This facility is a testing aid for alkaline manganese batteries only. It is of no significance for other battery types.**

If the flashing battery symbol appears, the remaining energy is still sufficient for a limited number of flashes. Some battery models may cause the warning indicator to flash prematurely, with about 50 % of their capacity left. Such batteries should be replaced only when really discharged (if recycling takes longer than 60 sec.).

The condition of the batteries can only be checked if the flashgun is switched on and after a few flashes have been fired.

2. Preparations

Mounting



Fig. 4: Fixing the flashgun

Mounting the flashgun on the camera

The flashgun can only be attached to the camera with the Standard Foot 301 or an SCA 300/SCA 3000 adapter (optional extra).

 **Before mounting or removing the flashgun, switch off both the camera and the flashgun**

Slip the flashgun into the camera's accessory shoe and lock it into position by turning down the knurled screw ④.

The standard version comes with the Standard Foot 301 which provides simple flash synchronisation, while the „Set“ version is supplied with the corresponding SCA adapter.

Removing the Standard Foot or SCA adapter:

- 1 Hold the rotary base ③ of the flashgun and swivel the body by 90°.
- 2 Press the retention catch in direction of the arrow.
- 3 Withdraw the Standard Foot or SCA adapter.

2. Preparations

Mounting, switching on and off

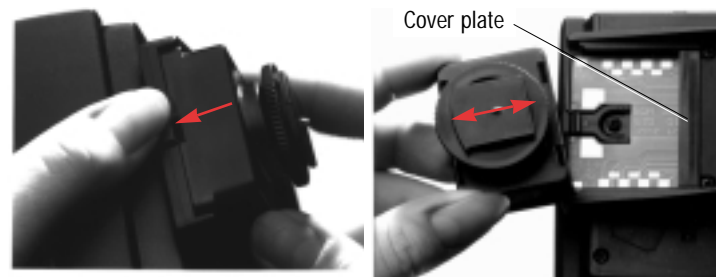

Fig. 5: Removing the Foot or SCA adapter

Mounting the Standard Foot or SCA adapter:

- Hold the cover plate (only when using the SCA 3000 adapter) in the centre and withdraw.
- Push the SCA adapter or Standard Foot 301 all the way in.
- Reset the rotary base ③ to its original position

Synch connection between flashgun and camera is automatically established when the flashgun is inserted into the camera's accessory shoe.

On cameras without a hot shoe, synchronisation is achieved with a synch cable (36-50, normal, or 36-52, coiled).

Switching the flashgun on and off

The flashgun is switched on with the main switch ①. It is permanently on when in ON position.

To switch off, push the main switch ① to the lower position.

 **If the flash unit is not going to be used for a prolonged period we**

recommend:

- Switch off the flash unit with the main switch
- Remove the source of power (batteries).

3. TTL flash mode

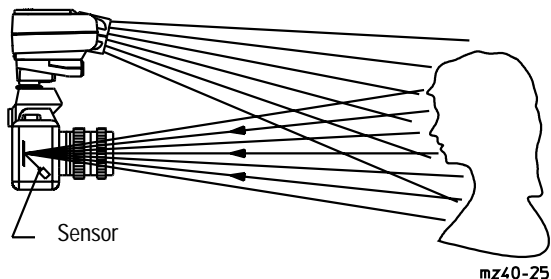

Fig. 6 : Measuring scheme for TTL mode

The direct way to good flash shots

i In TTL mode, the exposure readings are made by the sensor built into the camera (Fig. 6). This sensor measures the light reaching the film through the camera lens. An electronic control circuit within the camera transmits a stop signal to the flashgun as soon as the film has been exposed by the correct amount of light; the flash is then instantly cut out.

The advantage of this flash mode is that all factors influencing the correct exposure of the film, such as filters, change of aperture and focal length with zoom lenses, extensions for close-ups, etc. are automatically taken into account.

☞ The TTL flash mode can only be carried out with cameras that feature this function. The flashgun must be fitted with a corresponding SCA adapter (see SCA 300/3000 system instructions and SCA survey table).

Exposure corrections may be necessary with pronounced differences in contrast, for instance dark objects in snow (see ch. 15, p. 52).

3. TTL flash mode

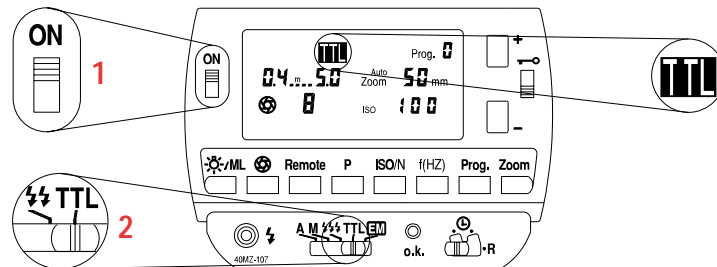

Fig. 7: Settings for TTL mode

Setting procedure for TTL mode:

- Adjust the camera according to the manufacturer's Operating Instructions.
- Fit the flashgun with the appropriate SCA adapter and mount it on the camera.
- 1** Switch on the flashgun with the main switch ①.
- 2** Set the operating mode selector ⑬ to TTL.
- *Press the **ISO** button ⑥ and adjust the film speed with the „+“ or „-“ button ⑨.
- *Press the **ZOOM** button ⑪ and use the „+“ or „-“ button ⑨ to adjust the zoom value selected with the camera's lens.
- If necessary, press the **P** button ⑤ and adjust the partial light output level with the „+“ or „-“ button ⑨ (e.g. in winder mode).
- *Press the button ③ and use the „+“ or „-“ button ⑨ to adjust the same aperture as on the camera.

*must additionally be set on some cameras.

☞ In the event that film speed and aperture are not transmitted automatically, there is no need to make these settings manually; they are insignificant for a correct exposure. They are, however, necessary for correct indication of the distance.

3. TTLflash mode

Easy Mode

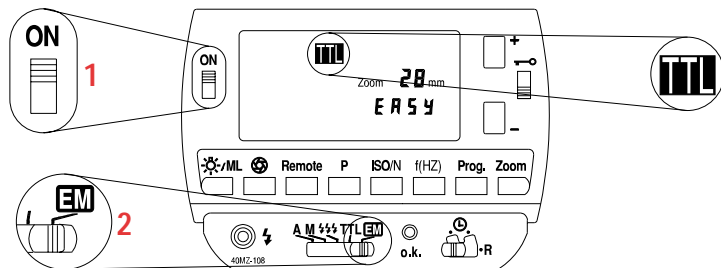

Fig. 8: Settings for TTL Easy Mode

This is the simplest way to operate the mecablitz in TTL flash mode. All buttons on the mecablitz are locked, with the exception of the \odot /ML ② and \downarrow ⑭ buttons.

In TTL Easy Mode with the SCA 300 adapter, the zoom position is constantly adjusted to 28 mm to ensure that the subject is always adequately illuminated.

In TTL Easy Mode with the SCA 3000 adapter, the zoom setting is matched to the focal length of the lens, and a distance range is indicated, provided that the camera supplies the zoom information.

We recommend the TTL Easy Mode when using an SCA 300 adapter. Distance indication on the LC display is not possible in this mode.

Setting procedure for TTL Easy Mode:

- Adjust the camera according to the manufacturer's operating instructions.
- Fit the mecablitz with the corresponding SCA adapter and mount it on the camera.

1 Switch on the mecablitz with the main switch ①.

2 Adjust the operating mode selector ⑬ to EM.

4. Automatic flash mode

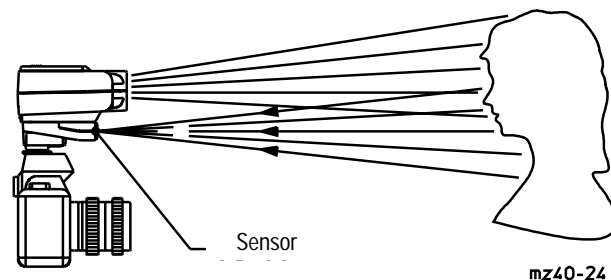

Fig. 9: Measuring scheme for auto mode

i In the auto flash mode, the flash unit's sensor ⑥ measures the light reflected from the subject. The flash is cut off as soon as sufficient light has been emitted for correct exposure.

This eliminates the need to recalculate and readjust the aperture each time the distance is changed, provided that the subject remains within the indicated auto flash range.

The flash unit's sensor ⑥ must be directed at the subject, regardless of the direction at which the main reflector ① is pointing. The sensor has a measuring angle of approx. 25° and takes measurements only during the emission of light by the flashgun in which it is integrated.

In the auto mode, also partial light output levels can be adjusted (see ch. 9, p.31).

Between six and twelve working apertures are available in the auto mode, depending upon the adjusted ISO film speed.

4. Automatic flash mode

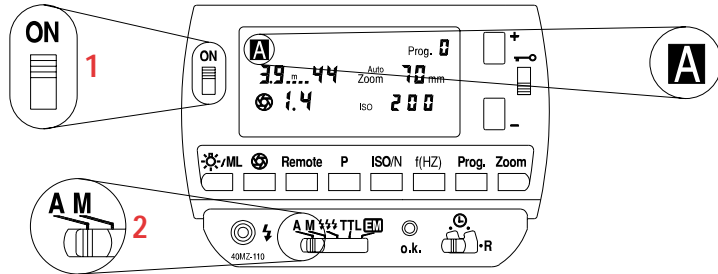

Fig. 10: Settings for the auto mode

Setting procedure for auto flash mode:

• Adjust the camera according to the manufacturer's Operating Instructions.

1 Switch on the flashgun with the main switch ①.

2 Set the operating mode selector ⑬ to **A**.

- *Press the **ISO** button ⑥ and set the film speed with the „+“ or „-“ button ⑨.
- *Press the **Zoom** button ⑪ and use the „+“ or „-“ button ⑨ to enter the zoom value selected on the camera lens.
- If necessary, press the **P** button ⑤ and adjust a partial light output level with the „+“ or „-“ button ⑨ (see ch. 9, p. 32).
- *Press the **Auto Aperture** button ③ and adjust the automatic aperture with the „+“ or „-“ button ⑨ until the desired distance range is indicated. This aperture must also be set on the camera lens.

*must additionally be set on some cameras

Hand icon: *If an SCA 3000 adapter is used, some cameras automatically transmit the f-number to the flash unit also in the auto flash mode. Should this be the case, the auto aperture need not be set on the flashgun.*

4. Automatic flash mode

The permissible distance range and the corresponding aperture appear on the LC display.

Hand icon: *The subject should be located within the middle third of this distance range, thus giving the electronic control sufficient scope for compensation, if necessary.*

There is a certain measure of overlap between the individual working apertures. As a result of this overlap it is always possible to place the subject within the middle third of the range.

Hand icon: *Caution with zoom lenses!*

Due to their design they can cause a loss of light in the order of up to one f-stop. Furthermore, the effective aperture can also vary, depending upon the adjusted focal length. This can be compensated by correcting the aperture on the flashgun manually!

5. Manual flash mode



Fig. 11: Shot with direct flashlight



In this mode, the flashgun will always emit its full power.

Adaptation to the actual picture shooting situation is by setting the corresponding aperture on the lens.

A single value for the flash-to-subject distance appears on the LC display while in manual mode.

If the displayed value does not coincide with the actual distance, then the aperture and/or partial light output level have to be changed accordingly (see ch. 9, p. 31).

The decisive points for the partial light output level are:

- Distance to the subject
- Desired aperture
- ISO film speed
- Zoom position of the reflector



The sensitive selection of partial light output levels makes it possible to adjust the distance to the subject in very small increments in the manual flash mode.

5. Manual flash mode

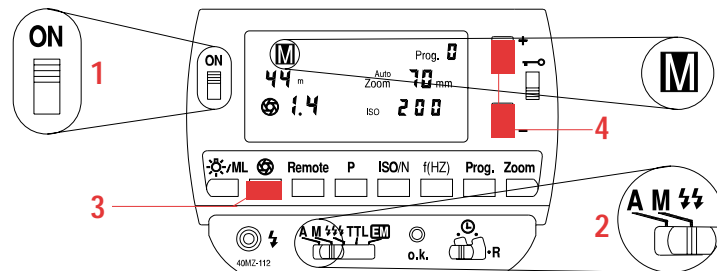

Fig. 12: Settings for manual mode

Setting procedure for manual flash mode:

- Adjust the camera according to the manufacturer's Operating Instructions.
- 1 Switch on the flashgun with the main switch ①.
- 2 Set the operating mode selector ⑬ to M.
- *Press the ISO button ⑥ and set the film speed with the „+“ or „-“ button ⑨.
- *Press the Zoom button ⑪ and use the „+“ or „-“ button ⑨ to set the zoom value that matches the focal length of the camera lens
- 3 Press the button ④ ③
- 4 Use the „+“ or „-“ button ⑨ to change the aperture on the flash unit until the desired distance appears on the LC display. This f-number must also be set on the camera lens.



If an SCA 3000 adapter is used, some cameras automatically transmit the f-number to the flash unit. Should this be the case, the f-number on the camera must be changed until the flash unit's LC display indicates the desired distance.

*must additionally be set on some cameras

6. Bounce flash

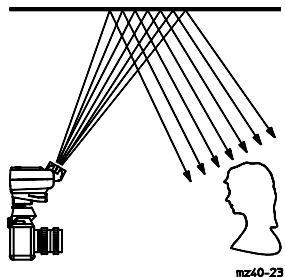

Fig. 13: Bouncing the flash (The photo was shot with the flash bounced off the right wall)

Photos shot with full frontal flash are easily recognized by their harsh, dense shadows. This is often associated with a sharp drop of light from the foreground to the background.

i This phenomenon can be avoided with bounce flash because the diffused light will produce a soft and uniform rendition of both the subject and the background. For this purpose the reflector **1** is turned in such a manner that the flash is bounced off a suitable reflective surface (e.g. ceiling or walls of a room).

The reflector can be turned vertically and horizontally. The vertical lock-in positions for bounce flash are:

- 60°, 75° and 90° (simply tilt the reflector to the required angle)

The flash head can be swivelled horizontally through 270°, and locks into position at 60°, 90°, and 180°.

☞ *The distance values on the LC display disappear as soon as the reflector is tilted upwards or the flash head turned horizontally. The distance from the flashgun to the ceiling or wall and from there to the subject is now an unknown factor.*

6. Bounce flash



Fig. 14: Lock-in positions of reflector and head

When turning the reflector **1**, or flash head, it is essential to ensure that it is moved by a sufficiently wide angle so that direct light can no longer fall on the subject. Therefore, always turn the reflector or head at least to the first lock-in position.

The diffused light bounced back from the reflective surfaces results in a soft illumination of the subject.

i *The reflecting surface must be white or have a neutral colour and it must not be structured (e.g. wooden beams in a ceiling), as these might cast shadows. For colour effects just select reflective surfaces in the desired colour.*

6. Bounce flash

Bouncing the flash in the auto and TTL modes

It is advisable to check prior to the actual exposure whether the light is sufficient for the selected aperture. Proceed in the manner described in ch. 14, p. 46.

Bouncing the flash in the manual mode

The required camera aperture in the manual mode is best established with an exposure meter. Observe the following rule of thumb if an exposure meter is not available:

$$\text{Camera aperture} = \frac{\text{Guide number}}{\text{Light distance} \times 2}$$

to establish a guide value for the aperture that can then be varied by + 1 f-stop for the actual exposure.

7. Metz cordless TTL remote operation

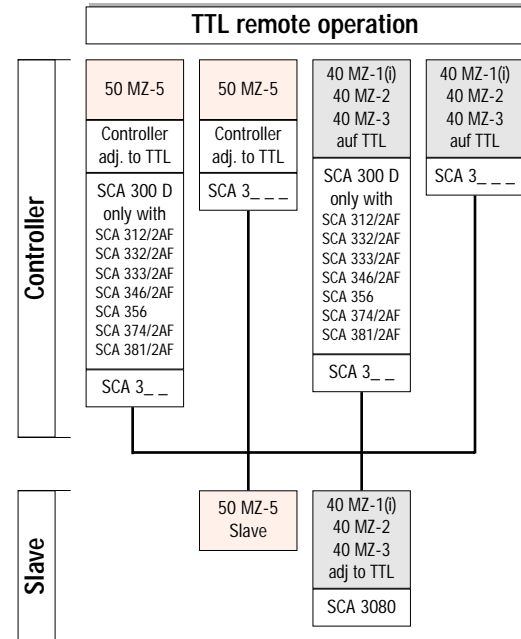

i Here, „remote operation“ means cordless firing of additional (slave) flashguns. The master flashgun (controller) mounted on the camera controls the additional flash units (slaves) in such a manner that automatic exposure control in TTL mode is extended to all slaves.

The Metz TTL remote operation permits joint cordless TTL flash control of several 40 MZ-... and 50 MZ-5 flash units. For this purpose all slaves must be fitted with an SCA 3080 Slave Adapter which is available as an optional extra. The slaves can be mounted on the stand supplied with the SCA 3080 or on a tripod.

7. Metz cordless TTL remote operation

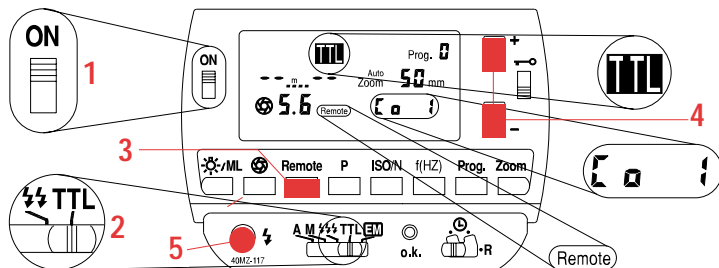

Fig. 15: Settings for TTL remote operation

Setting procedure for Metz TTL remote operation:

- Adjust the camera to TTL mode, as explained in the manufacturer's Operating Instructions.
- 1 Switch on the flashgun mounted on the camera with the main switch ①.
- 2 Set the operating mode selector ⑬ to TTL.
- 3 Press the **Remote** button ④ on the flashgun mounted on the camera.
- 4 Use the „+“ button ⑨ to select the controller address **Co 1** or **Co 2**.
 - Fit each slave with an SCA 3080 Slave Adapter, switch on with the main switch ①, and set the operating mode selector to TTL: The slaves are now in slave mode.
- 5 Press the manual firing button ⑭ on the flashgun mounted on the camera and fire a test flash.
 - The slave unit responds with a delayed flash, thus confirming that it is ready for operation. If several slaves are used at the same time, all will react simultaneously. The LC display indicates SL 1 or SL 2, depending on the controller address selected (Fig. 15). If, after a test flash has been fired, proper function is not confirmed by one of the slave units in the form of a delayed flash, then the sensor ⑥ in the SCA adapter has not received any light pulse. Should this be the case, rotate the rotary base ③ of the flash unit so that the sensor ⑥ can receive a light pulse, and repeat step 5.

7. Metz cordless TTL remote operation

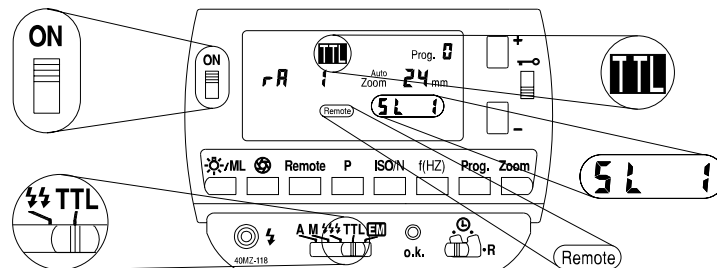

Fig. 16: Display for operation with slaves

- ☞ *A particularly short distance between controller and slave unit may cause the camera's electronics to cut off the flash before the slave has received its light pulse. In such an event widen the distance or choose a larger f-number and repeat step No. 5.*

To ensure that two TTL remote systems in the same room do not interfere with each other, two different addresses can be selected on the controller. These are then automatically transferred to the slave units after a test flash.

Checking the slave address:

The Co1 or Co2 controller address is permanently adjusted after a test flash has been fired in the manner described in step No. 5. The address setting can only be changed by switching the slave off and on again, and by repeating the steps No. 4 and 5. Please check the display to establish the address to which the slave has been adjusted. Co1 and SL1 indicate that the controller and slave unit are both adjusted to address 1. Alternately, Co2 and SL2 indicate address 2.

rA1 and rA2 (not with SCA 3080-M1 adapter) in the distance range indication on the LC display can be ignored in these instances.

7. Metz cordless TTL remote operation

Indication that flash readiness has been reached is particularly important for TTL remote operation. If flash readiness is established, the AF measuring beam

⑦ on the slave gives brief light pulses and the flash-ready indicator ⑭ is lit.

Switching off the Metz TTL remote operation:

- Press the Remote button ④ on the controller twice.
- On the slave unit:
Switch off the flashgun, remove the Slave Adapter SCA 3080 and switch on the flashgun again.

7.1 Metz cordless auto remote operation

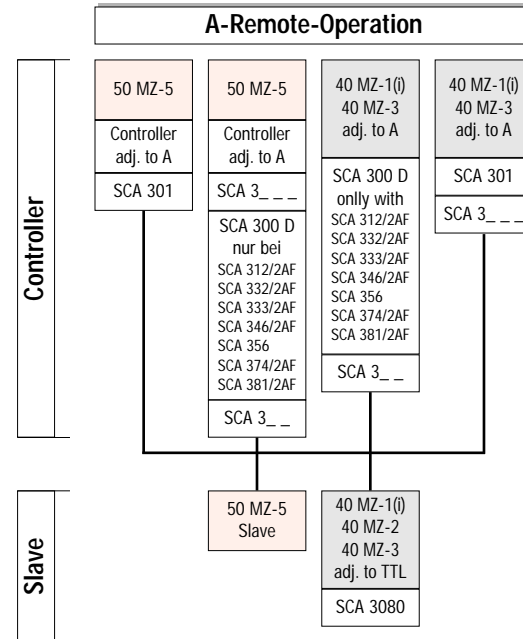

i In the Metz A remote mode the master flashgun (controller) mounted on the camera controls the slaves in such a manner that automatic operation covers all slave units. The exposure is controlled by the sensor ⑥ on the controller. To implement this mode, all 40 MZ... slave units must first be fitted with an SCA 3080 Slave Adapter (available as an optional extra). 50 MZ-5 slaves do not require a slave adapter.

7.1 Metz cordless auto remote operation

 *The Metz A remote operation can be used with system, standard, old mechanical and medium-format cameras.*

The only precondition is that all cameras feature a synch contact/socket, and are equipped with a 301 Standard Foot or SCA adapter.

Setting procedure for Metz A remote operation:

- Adjust the camera to manual mode as explained in the manufacturer's operating instructions.
- Set a shutter synch speed of 1/60th sec. or slower on the camera.
- Switch on the master flashgun (controller) attached to the camera with the main switch ①.
- Adjust the operating mode selector ⑬ to **A**.
- Press the **Remote** button ④ on the Mecablitz mounted on the camera. The distance values on the LC display disappear.
- Select the controller address **Co 1** or **Co 2** with the + button ⑨.
- Fit the **40 MZ-.. slave units** with an SCA 3080 Slave Adapter; switch on with the main switch and adjust to TTL. The 40 MZ-.. slaves are now in slave mode. Separate the **50 MZ-5 slaves** from the controller, and switch on with the main switch.
- Press the manual firing button ⑭ on the controller attached to the camera, and fire a test flash.
- The slave will respond with a delayed flash, thereby indicating that it is ready for operation. All slave units simultaneously acknowledge operating readiness when several slaves are being jointly used. If you find that a slave unit does not respond, this may indicate that the sensor ⑥ on the slave did not receive a light pulse. Turn the flashgun in such a manner that the sensor ⑥ can receive the light pulse from the master flash (controller). Now fire another test flash. A particularly short distance between master flash and slave can result in over-modulation of the sensor. In this case widen the distance and repeat the test flash.

7.1 Metz cordless auto remote operation

Proceed as described in ch. 7 to **check and change the slave address**, and to **switch off** automatic remote operation. To assess the overall lighting conditions, press the **ML** button ② for at least 2 seconds. This will trigger a modelling light (approx. 4 seconds). All slaves (40 MZ-1(i) and MZ-3 with SCA 3080 M-1 adapter) likewise emit a modelling light.

8. Winder mode



The winder mode involves shooting a sequence of pictures at a rate of several frames per second. It is a manual mode with partial light output levels, and is only recommended with NiCad batteries or high-power alkaline manganese batteries. Table 5 of the Technical Data indicates which partial light output level is suited for a given frame frequency (frames per second = flashes per second).

Using the winder in the manual mode

In the manual mode, the exposures are made with a fixed partial light output level selected in conformity with the winder data given in Table 5 of the Technical Data.

Using the winder in auto and TTL modes

In these modes it is possible to ensure that a flash will be fired with each exposure of a series of pictures. For this purpose a partial light output level can be adjusted in conformity with the winder data (Table 5).

 ***Shots that require less light are automatically controlled by the automatic or TTL light output system and are, therefore, correctly exposed.***

Shots that require more light than the adjusted partial light output level may be underexposed!

9. Working with partial light output levels



Partial light output levels are manually adjustable fractions of the full-power light output.

Partial light output levels can be set in all operating modes except the TTL remote mode. The recycling times are shorter when partial light output levels are adjusted (see Technical Data, Table 1) instead of full-power flashes. At the same time the guide number of the flashgun is diminished, together with the flash-to-subject distance or flash range, because only part of the flash power is emitted.

 ***Partial light output cannot be set for TTL remote operation. In stroboscopic mode, the maximum possible partial light output is always indicated.***

Partial light output levels in the auto mode

Partial light output may be adjusted in the auto mode to ensure that a flash is always triggered with serial shots (winder mode).

The actual light output level for a given flash frequency and number of flashes is specified in Table 5 of the Technical Data.

Partial light output levels in the manual mode

Some situations make it necessary to reduce the amount of light emitted by the flashgun because the selected flash-to-subject distance may result in an excessively high f-number and undesired large depth of field. This is where the partial light output level function comes to the rescue.

The partial light output levels are adjustable within very close increments. The distance value of the flashgun can therefore be easily matched to the subject distance if a specific aperture has to be retained. Thus, professional flash photography is made possible in a very simple manner to deal with difficult situations (great differences in contrast, extreme level of reflection) when the automatic system would not produce optimal results.

9. Working with partial light output levels

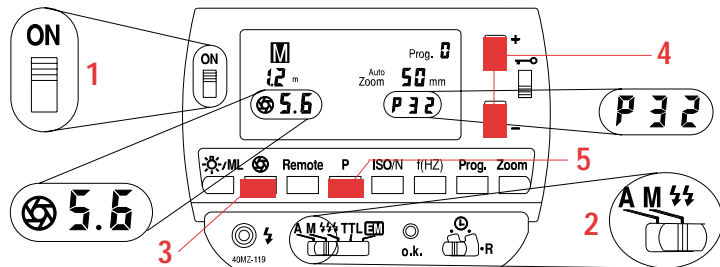

Fig. 17: Partial light output levels in the manual mode

Setting procedure for manual mode with partial light output:

- Adjust the camera in the manner described in the operating instructions.

- 1 Switch on the flashgun with the main switch ①.
 - 2 Adjust the operating mode selector ⑬ to M.
 - *Press the ISO button ⑥ and then adjust the film speed with the + or - button ⑨
 - *Press the Zoom button ⑪ and use the + or - button ⑨ to adjust the zoom value that equals the focal length of the camera lens.
 - 3 Press the ③ button.
 - 4 Use the + or - button ⑨ to continuously change the flashgun's aperture until the required aperture appears on the LC display. Now set the same aperture on the camera.
- ☞ *If an SCA 3000 adapter is used, some cameras automatically transmit the f-number. Should this be the case, the aperture on the camera must be changed until the required f-number appears on the LC display of the flashgun.*
- 5 Press the P button ⑤, and then use the + or - button ⑨ to continuously change the partial light output level until the required distance appears on the LC display.

* must additionally be set on some cameras

9. Working with partial light output levels

Flash durations

The adjustable partial light output levels result in different flash durations (see Technical Data, Table 1). The specified flash durations apply only to single flashes in manual mode. With serial flashes (winder or stroboscopic mode) the last flashes may have a longer duration. Flash duration in the auto and TTL modes can also be shorter when the automatic exposure control switches off the flash at an earlier moment.

Macrophotography (close-ups)

Parallax error can be compensated by tilting the main reflector downwards by -5° or -13° . For this purpose pull the reflector completely out, and then tilt it down.

With close-up photography it is important to ensure that a certain minimum lighting distance is maintained to avoid overexposure.

For exposures with extremely short flash-to-subject distances, we advise you to use small partial light output levels in manual mode, as described on page 31.

10. Stroboscopic mode



Fig. 18: Stroboscopic mode

i In this mode several flash exposures are made on the same frame. This is particularly interesting for motion studies and for special effects (Fig. 18).

In stroboscopic mode, several flashes are fired at a certain flash frequency. Consequently, this function is only possible with a partial light output level of $\frac{1}{4}$ max. or less.

For a stroboscopic exposure it is possible to select a flash frequency of 1...30 Hz in 1 Hz increments, and a number of flashes of 2...20 in single increments.

The maximum possible partial light output level in stroboscopic mode is automatically adjusted (see Technical Data, Table 5). The partial light output level can be adjusted manually to the minimal value of 1/256 to achieve short flash durations. The LC display indicates the distance applicable to the adjusted parameters. The displayed distance value can be adjusted to the actual shooting distance by varying the f-stop or the partial light output level. The aperture adjusted on the flashgun must be transferred to the camera. The distance range can be increased by loading a high-speed film.

10. Stroboscopic mode

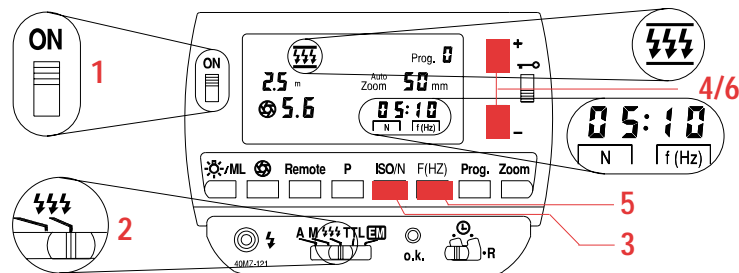



Fig. 19: Settings for stroboscopic mode

Setting procedure for stroboscopic mode:

- Adjust the camera to manual mode, as explained in the manufacturer's Operating Instructions, and select the matching shutter speed (see Technical Data, Table 5).
- 1** Switch on the flashgun with the main switch ①.
- If the film speed has not yet been set on the mecablitz:
 - Adjust the operating mode selector ⑬ to **A**.
 - Press the **ISO** button ⑥ and set the film speed with the „+“ or „-“ button ⑨
- 2** Adjust the operating mode selector ⑬ to .
- *Press the **Zoom** button ⑪ and use the „+“ or „-“ button ⑨ to set the zoom value selected on the camera lens.
- 3** Press the button **N** ⑥ (double function of the **ISO** button).
- 4** Enter the desired number of flashes **N** with the „+“ or „-“ button ⑨.
- 5** Press the **f(HZ)** button ⑦.
- 6** Enter the desired flash frequency **f(Hz)** with the „+“ or „-“ button ⑨.
- If necessary, press key **P** ⑤ and use the „+“ or „-“ button ⑨ to reduce the partial light output level.

10. Stroboscopic mode

- *Press the button  ③. Then use the „+“ or „-“ button ⑨ to select an aperture that matches the distance to the subject. Set this aperture also on the camera.

*must additionally be set on some cameras

 **The distance to the moving subject is used as the distance value. To prevent overexposure of the motionless background this should either be very dark or far behind the moving subject. The best results are achieved at a low ambient light level.**

Table 5 of the Technical Data specifies the maximum partial light output levels for the N - f(Hz) combinations.

Ensure that an adequately slow shutter speed is set on the camera.

Table 6 of the Technical Data specifies the fastest shutter speeds for the N - f(Hz) combinations.

11. Fill-in flash in daylight



Fig. 20: Fill-in flash in daylight

The mecablitz can also be used for fill-in flash in daylight to soften harsh shadows and lower the contrast, thereby producing a more balanced exposure when shooting against the light. Various possibilities are open to the user for fill-in flash.

Fill-in flash in auto mode

Use the camera, or a hand-held exposure meter, to establish the required aperture and shutter speed for a normal exposure. Ensure that the shutter speed either equals, or is slower than, the fastest flash synch speed (varies with different camera models).

Example:

Established aperture = f/8; established shutter speed = 1/60th sec.

Flash synch speed of the camera e.g. 1/100th sec. (see operating instructions for the given camera).

The two established values for aperture and shutter speed can be set on the camera because the camera's shutter speed is slower than the camera's flash synch speed.

To maintain a balanced range of highlights, for instance in order to retain the character of the shadows, it is advisable to select the automatic aperture on the flashgun one setting lower than the aperture adjusted on the camera. In our example f/8 was set on the camera. Consequently, we advise you to adjust f/5.6 as the aperture setting on the flashgun.

11. Fill-in flash in daylight

 *When shooting into the light ensure that the backlight does not shine directly onto the sensor as this will confuse the flashgun's electronics.*

Fill-in flash in manual mode

The partial light output levels can be used in manual flash mode to achieve the desired brightening effect of fill-in flash.

Complete illumination of shadow areas

Use the camera, or a hand-held exposure meter, to establish the required aperture and adjust this value on both the camera and flashgun. The aperture adjusted on the camera is automatically transferred to the flashgun when an SCA 3000 adapter is used in conjunction with a data compatible camera. The given range of the flashgun is indicated on the LC display. If the distance to the subject is shorter than the indicated flash range, then select a partial light output level to match the distance. For this purpose continue pressing the **P** button and the „-“ button until the flash range and subject distance coincide.

Graduated brightening effect

Use the camera, or a hand-held exposure meter, to establish the required aperture and adjust this value on both the camera and flashgun. The aperture adjusted on the camera is automatically transferred to the flashgun when an SCA 3000 adapter is used in conjunction with a data compatible camera. To diminish the brightening effect compared with complete illumination, adjust the partial light output levels in such a manner that the setting is advanced by 1/3 f-stop with each depression of the button.

11. Fill-in flash in daylight

Fill-in flash in TTL mode

Some camera models automatically control fill-in flash when in program or automatic mode. The manner of camera internal fill-in flash control varies greatly between the different modern camera models, making it impossible to give a precise description of the individual adjusting procedures. These are normally given in the operating instructions for the given camera. Shadows can also be brightened with a flashgun in TTL mode on cameras that do not feature a special fill-in program or setting. In such cases the effect of fill-in flash depends upon the properties of the camera's TTL metering system. Consequently, in many instances it will be advisable to use fill-in flash in automatic mode.

12. Working with user programs

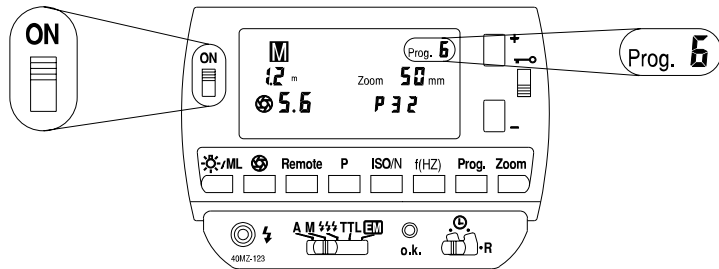

Fig. 21: Display of an activated user program

i Your flashgun is provided with a memory that will enable you to enter your own flash programs on nine program places. This is particularly advantageous for constantly recurring flash situations.

Program 0 (Prog.0) is loaded when the flashgun is operated for the first time. The home program place 0 covers the standard operating range of the flashgun.

The data that were active just before the flashgun was switched off are stored in program 0. If, prior to switch-off, the data were loaded in program 7 and one or more of the parameters were changed, then it is possible that program „0“ will be indicated. If the flashgun is now switched off, the data will be stored and presented in an unchanged form on program „0“ when the flashgun is switched on again.

The 9 program places have been assigned in the factory as specified in Table 3 of the Technical Data.

The second STO and RCL functions assigned to the buttons are displayed only after the Prog. button has been depressed. The second functions are:

STO = STORE the values indicated on the LC display.

RCL = RECALL = Load the stored data of a user program.

12. Working with user programs

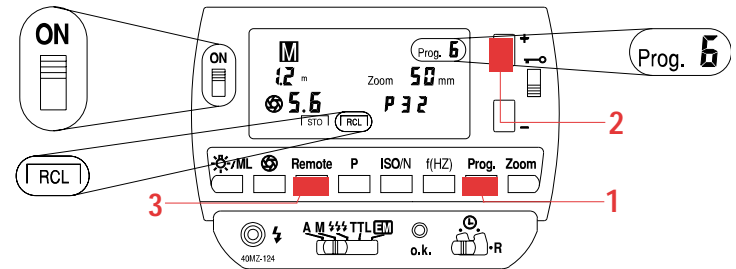

Fig. 22: Calling a stored user program

When proceeding from program 0 - as the home program with the standard operating range - to transfer to another program with RCL (Recall), the data of the standard working range are first stored in the home program place 0 before the new data of the selected program place can be read from the memory.

In the event that the original standard operating data have to be reactivated, then the home program place 0 is merely recalled.

If a new program place is called without subsequently pressing the buttons STO (Store) ④ or RCL (Recall) ⑤ then, after 5 seconds, the flashgun automatically switches back to the previously adjusted program place.

Calling a stored program:

- 1 Press the **Prog.** button ⑥; Prog. flashes.
- 2 Select the desired program place Prog. ? with the „+“ button ⑨.
- 3 Press the button **P (RCL)** ⑤.
The program is now loaded and can be used.

A flashing mode symbol on the LC display after a user program has been called indicates a deviation from the setting of the operating mode selector. However, this does not have any influence on the actual exposure. To turn off the flashing symbol, adjust the operating mode selector to the mode that is flashing on the LC display.

12. Working with user programs

If, for example, the operating mode is changed after a stored program has been called, the LC display switches to „Prog.0“. But the unchanged parameters of the previously loaded program place are retained.

The factory-set flash programs can be overwritten if you wish to store your own flash programs. Five stickers, included with the flashgun, can be inscribed as a memo when storing your own program places.

Procedure for storing a program:

- Select the required settings (aperture, zoom, operating mode, etc.) for subsequent application.
- Press the **Prog.** button ⑧; Prog. flashes.
- Use the „+“ or „-“ button ⑨ to select the program place Prog. ? where the settings are to be stored.
- Hold the **Remote (STO)** key ④ for abt. 3 seconds depressed until the **STO** and **RCL** symbols go out. The settings are stored after the **STO** and **RCL** symbols have gone out.

 *The last settings made on program place 0 are retained when the flashgun is switched off. These settings are reactivated when the flashgun is switched on again, provided that the batteries were not removed from the flashgun.*

13. The zoom reflector

The zoom reflector (main reflector)

The camera can automatically adjust the zoom reflector ❶ to the focal length of the lens; alternatively, this can also be done manually with the Zoom button ❶ and the „+“ or „-“ buttons ⑨.

Zoom 20: Illumination with wide angle diffuser (for 35 mm, from 20 mm focal length onwards)

Zoom 24: Wide-angle illumination (for 35 mm, from 24 mm focal length onwards)

Zoom 28: Wide-angle illumination (for 35 mm, from 28 mm focal length onwards)

Zoom 35: Wide-angle illumination (for 35 mm, from 35 mm focal length onwards)

Zoom 50: Standard illumination (for 35 mm, from 50 mm focal length onwards)

Zoom 70: Telephoto illumination (for 35 mm, from 70 mm focal length onwards)

Zoom 85: Telephoto illumination (for 35 mm, from 85 mm focal length onwards)

Zoom 105: Telephoto illumination (for 35 mm, from 105 mm focal length onwards)

For manual zoom control press the Zoom button ❶ and adjust the desired zoom setting with the „+“ or „-“ button ⑨.

In the event that your camera with SCA adapter automatically transfers the zoom setting of the lens, simply press the Zoom button ❶ twice to reactivate automatic zoom control after a manual zoom reflector adjustment.

13. The zoom reflector

Ex-Zoom-mode

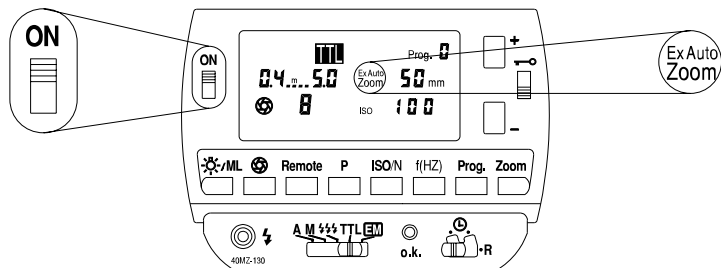

Fig. 23: Settings for Ex-Zoom mode

Ex-Zoom mode (extended zoom)

The Ex-Zoom mode can only be used with system cameras that are capable of exchanging data via the SCA 3000 adapter.

This mode was created for professional use during reporting work in dense crowds. In the extended zoom mode, the flashgun's zoom reflector position is automatically adjusted one increment further towards a wider angle in relation to the focal length of the camera lens, to guarantee wider coverage.

Example: Focal length of camera lens 50 mm; zoom reflector setting 35 mm

The flashgun's larger angle of coverage provides a higher safety margin for perfect lighting of the subject. In normal operation, the Ex-Zoom mode produces a softer illumination of the subject because more light is reflected back from the walls and ceiling.

Setting procedure for the Ex-Zoom mode:

- Switch off the flashgun with the main switch ① for approx. 5 seconds.
- Hold down the zoom button ⑩ on the flashgun.
- Switch on the flashgun with the main switch ①.
- Release the zoom button ⑩.
- Proceed in the same sequence to switch off the ex-zoom mode.

13. The zoom reflector

Wide angle diffuser

Pull-out/push-in wide-angle diffuser

Pull out the wide-angle diffuser ⑧ under the main reflector, all the way to the front. Then release it. This causes the main reflector to automatically advance to zoom position 20 mm. The wide-angle diffuser automatically folds up, and the distances and zoom value on the LC display are modified accordingly.

To push in the wide-angle diffuser, press on the left and right-hand guide rails of the black guide plate. The wide-angle diffuser will fold down and can then be pushed in completely.

14. Special functions

Exposure o.k.

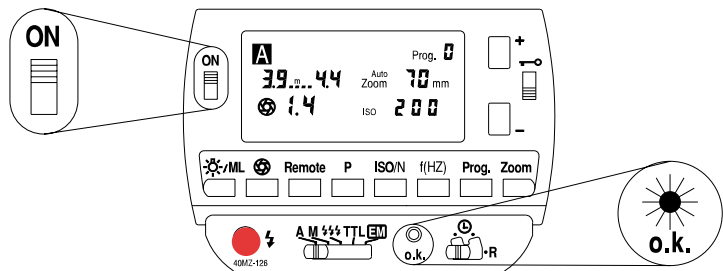

Fig. 24: Exposure o.k.

The correct exposure indicator („o.k.“) ⑨ lights up only when the frame will be, or was, correctly exposed in the auto and TTL mode.

In this manner it is possible to manually trigger a test flash while in auto mode so that the correct aperture can be established beforehand. This is particularly valuable with bounced flash when reflection conditions are difficult to judge.

1 The test flash is triggered with the manual firing button ⑭ (fig. 24).

If the exposure o.k. indicator ⑨ remains dark after the test flash was fired, then adjust the next larger aperture (smaller f-number) or diminish the distance to the reflection surface or subject, and repeat the test flash.

The f-stop established in this manner must also be set on the camera.

☞ **To trigger a test flash, hold the camera and flashgun in the same manner as for the actual shot.**

This facility can also be used with TTL mode without having to produce test exposures. The flashgun is adjusted to auto mode, and the correct aperture is then determined with a test flash in the previously described manner. The established aperture is transferred to the camera, and the flashgun is then readjusted to TTL mode.

This procedure is relatively accurate with lenses of medium focal length of between 28 mm and 85 mm. But in borderline cases underexposure may occur with subsequent TTL exposure.

14. Special functions

AF measuring beam

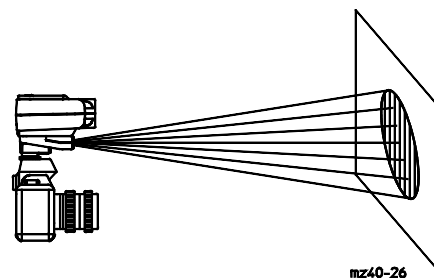

Fig. 25: The AF measuring beam

In such an event the exposure o.k. display ⑨ remains dark after the shutter has been released. Select the next larger f-stop (e.g. f/8 instead of f/11), and repeat the exposure.

AF measuring beam

As the release or other sensory control of the camera is operated, the integrated AF measuring beam ⑦ is automatically activated in the event of low lighting levels or with a low-contrast subject. The measuring beams project a light pattern onto the subject (Fig. 25). The camera's autofocus system uses the light reflected from the subject to measure image sharpness and focus the lens. The range of the AF measuring beam ⑦ is approx. 9 m with a 50 mm f/1.7 lens.

☞ **This function is only available with specific AF cameras in conjunction with an SCA 3000 adapter.**

14. Special functions

Rapid - / ML-functions

The Rapid function

Recycling times in the A and TTL modes depend on the amount of light required for the shot. Recycling takes 11 seconds max. when full-power flashes are fired. Should this be too long, the Rapid function comes to the rescue.

Use of the Rapid function is especially valuable when taking shots inside a room, where fast recycling is more important than a maximum light output. However, the guide number is reduced by 1 increment, e.g. from GN 40 (with ISO 100/21° film - 50 mm zoom) to GN 28 (with ISO 100/21° - 50 mm zoom).

☞ *Partial light output levels are not possible with the Rapid function.*

The ML function (Modelling Light)

The **ML** button ② on the flashgun triggers a modelling light for approx. 4 seconds to allow assessment of the shadows, particularly in remote control modes. When the **ML** button is pressed on the controller (master flashgun), all slaves of the type 40 MZ-1(i) and 3(i), and 50 MZ-5 will simultaneously emit such modelling light. 40 MZ-.. slaves must be fitted with an SCA 3080 adapter for this purpose. Hold down the **ML** button ② for at least 2 seconds to trigger the modelling light and release the **ML** button ② the moment the modelling light lights up. Switch off the mecablitz if you wish the light to be cut off.

☞ *The modelling light can be triggered about 60 times with a fully charged battery.*

This mode is not suitable with battery operation.

14. Special functions

Locking

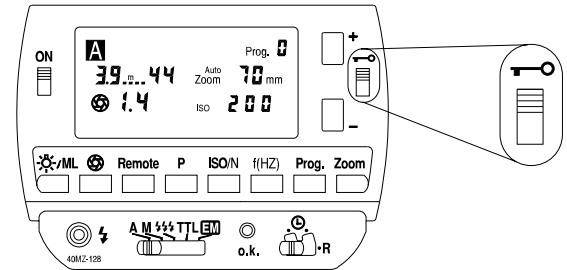

Fig. 26: Locking the controls

Locking the controls (key function)

Switch ⑩ locks all buttons and switches to prevent inadvertent readjustment during flash operation.

The buttons ⚙️ /ML ② and ⚡ ⑭ as well as the main switch ① will not be locked.

14. Special functions Automatic cut-out

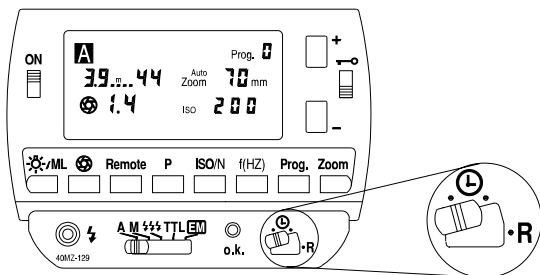

Fig. 27: Automatic cut-out

Automatic cut-out

If you set the multi-function switch (12) to the „clock symbol“, the flashgun is automatically switched off approximately 10 minutes after it was last used, thus protecting the batteries against inadvertent discharge.

The last used operating mode, or the last set user program is retained when the flashgun is switched off so that it becomes instantly available when the flash is switched on. Press the „+“ or „-“ button (9) to switch on again

14. Special functions m-ft display

Testing the LCD segments and m-ft changeover (Service Menu)

The Service Mode 1 has to be called in order to check the LCD segments and to change over the dimensional units (m = meter; ft = feet).

Only complete the settings described here! Do not press any other buttons than those described here, otherwise there is the danger that programmed data and user programs will be lost!

Calling the Service Mode 1:

- Press the button (2) for the LC display light and **simultaneously** slide the main switch (1) from OFF to ON. If a Pentax adapter is used, hold down button (2) for at least 2 seconds after sliding the main switch (1).
- SER1 and m or ft flash, and an index number, e.g. 1.0 is indicated.

Adjusting the dimensional units:

- m or ft is selected with the „+“ button (9).

Testing the display segments:

- Remove the adapter from the mecablitz.
Press the button (2) for the LC display light. All segments of the LC display must be indicated.

Return to the User Menu:

- Slide the main switch (1) to OFF, and then to ON again.

15. Exposure corrections

The automatic exposure systems are adjusted to a subject reflection factor of 25%, this being the average reflection factor for subjects shot with flash.

Dark backgrounds that absorb a lot of light, or bright backgrounds that reflect a great deal of light (e.g. backlit scenes), can result in overexposure or underexposure of the subject, as the case may be.

Exposure corrections in auto mode

To compensate the above described effect, exposure can be corrected by opening or stopping down the camera's aperture. If the background is mainly bright, the flashgun's sensor will cut off the flash too soon with the result that the subject will be underexposed. With a dark background the flash is cut off too late so that the subject looks too light.

 **Bright background:**
open the aperture 1/2 to 1 f-stop
(e.g. from f/5.6 to f/4)

Dark background:
close the aperture 1/2 to 1 f-stop
(e.g. from f/8 to f/11)

Exposure corrections in TTL mode

Many cameras have an adjusting facility for exposure correction which can also be used in TTL flash mode.

 **Note: Please observe the corresponding explanations in the Operating Instructions for the camera or SCA adapter.**

Here, exposure correction by changing the aperture on the lens is not possible. This is because the camera's automatic exposure system will regard the changed f-stop as a normal working aperture.

16. Technical Data

Partial light output P=Flash Power	Flash duration in seconds	LC-display	Guide number at ISO 100 50 mm zoom
1	1/200	1	40
1 - 1/3		1 ₋	
1/2 + 1/3		2 ₋	
1/2	1/600	2	28
1/2 - 1/3		2 ₋	
1/4 + 1/3		4 ₋	
1/4	1/1500	4	20
1/4 - 1/3		4 ₋	
1/8 + 1/3		8 ₋	
1/8	1/3000	8	14
1/8 - 1/3		8 ₋	
1/16 + 1/3		16 ₋	
1/16	1/5000	16	10
1/16 - 1/3		16 ₋	
1/32 + 1/3		32 ₋	
1/32	1/8000	32	7
1/32 - 1/3		32 ₋	
1/64 + 1/3		64 ₋	
1/64	1/13000	64	5
1/64 - 1/3		64 ₋	
1/128 + 1/3		128 ₋	
1/128	1/20000	128	3,5
1/128 - 1/3		128 ₋	
1/256 + 1/3		256 ₋	
1/256	1/26000	256	2,5

Table 1: Flash durations at the individual partial light output levels

16. Technical Data

ISO	APERTURE							
6-8	1	1,4	2	2,8	4	5,6	8	11
10-12-16	1	1,4	2	2,8	4	5,6	8	11
20-25-32	1	1,4	2	2,8	4	5,6	8	11
40-50-64	1	1,4	2	2,8	4	5,6	8	11
80-100-125	1	1,4	2	2,8	4	5,6	8	11
160-200-250		1,4	2	2,8	4	5,6	8	11
320-400-500			2	2,8	4	5,6	8	11
640-800-1000				2,8	4	5,6	8	11
1250-1600-2000					4	5,6	8	11
2500-3200-4000						5,6	8	11
5000-6400							8	11

Table 2: Working aperture ranges

Prog.	Mode	Partial light output	Number of flashes N	Freq. f(Hz)	ISO	Remarks
1	TTL	P 1	-	-	100	
2	TTL	P 1	-	-	100	
3	TTL	P 16	-	-	100	
4	A	P 1	-	-	100	
5	A	P 16	-	-	100	
6	M	P 32	-	-	100	5 frames/sec.
7	Strobo	P 16	5	1	100	
8	Strobo	P 32	10	5	100	
9	M	P 2	-	-	400	

Table 3: Factory-assigned program places (zoom 50, f/5.6)

16. Technical Data

ISO	Zoom setting - Main reflector							
	20	24	28	35	50	70	85	105
6/9°	5,5	7	8	8,5	10	11	11,5	12,5
8/10°	6	8	9	10	11	12,5	13	14
10/11°	7	9	10	11	13	14	14,5	16
12/12°	8	10	11	12	14	15,5	16	18
16/13°	9	11	12,5	14	16	18	18,5	20
20/14°	10	12,5	14	15	18	20	20,5	22
25/15°	11	14	15,5	17	20	22	23	25
32/16°	12,5	16	17,5	19	23	25	26	28
40/17°	14	18	20	21,5	25	28	29	32
50/18°	15,5	20	22	24	28	31	32,5	35
64/19°	18	22,5	25	27	32	35	37	40
80/20°	20	25	28	30	36	39	41	45
100/21°	22	28	31	34	40	44	46	50
125/22°	24,5	31	35	38	45	49	51	56
160/23°	28	35,5	39	43	50,5	56	58	63
200/24°	31	39,5	44	48	56,5	62	65	71
250/25°	35	44	49	54	63	69,5	73	79
320/26°	39	50	55,5	61	71,5	79	82	89
400/27°	44	56	62	68	80	88	92	100
500/28°	49	62,5	69	76	89	98	103	112
650/29°	56	71	79	87	102	112	117	127
800/30°	62	79	87,5	96	113	124	130	141
1000/31°	69,5	88,5	98	108	126	139	145	158
1250/32°	78	99	110	120	141	156	163	177
1600/33°	88	112	124	136	160	176	184	200
2000/34°	98	125	139	152	179	197	206	224
2500/35°	110	140	155	170	200	220	230	250
3200/36°	124	158	175	192	226	249	260	283
4000/37°	139	177	196	215	253	278	291	316
5000/38°	156	198	219	240	283	311	325	354
6400/39°	176	224	248	272	320	352	368	400

Table 4: Guide numbers at maximum light output (P1)

16. Technical Data

Number of flashes (N)	2-4	1/8
	5-7	1/16
	8-12	1/32
	13-20	1/64
Partial light output (P)		

Table 5: Maximum partial light output levels in stroboscopic mode

Example:

You intend to make a stroboscopic shot with 7 flash exposures at a frequency of 3 flashes per second.

Procedure:

After having completed the first six settings described in „Setting procedure for stroboscopic mode“, press the button N and then enter the number of exposures - in this case 7 - with the „+“ or „-“ button. Then press the button f(Hz), followed by the entry of the flash frequency - in this case 3 - with the „+“ or „-“ button. The maximum possible partial light output level is automatically adjusted to 1/16. The partial light output level can also be manually adjusted to a smaller value.

 **The values specified in the tables only apply to fully charged NiCad batteries or to new high power alkaline-manganese batteries. For batteries that have been used it is necessary to adjust the next smaller main partial light output level (e.g. adjust 1/16 instead of 1/8) to ensure that the number of flashes is achieved with certainty.**

16. Technical Data

You have now adjusted the number of flashes = 7 and the flash frequency = 3; the maximum partial light output level of 1/16 has been adjusted automatically.

Table 6 shows you the aperture to be set on the camera.

Flash frequency f(Hz) (Flashes/sec.)	Number of flashes										
	2	3	4	5	6	7	8	9	10	15	20
1	2	4	4	8	8	8	8	15	15	15	30
2	1	2	2	4	4	4	4	8	8	8	15
3	1	1	2	2	2	4	4	4	4	8	8
4	1/2	1	1	2	2	2	2	4	4	4	8
5	1/2	1	1	1	2	2	2	2	2	4	4
6	1/2	1/2	1	1	1	2	2	2	2	4	4
7	1/2	1/2	1	1	1	1	2	2	2	4	4
8	1/4	1/2	1/2	1	1	1	1	2	2	2	4
9	1/4	1/2	1/2	1	1	1	1	1	2	2	4
10	1/4	1/2	1/2	1/2	1	1	1	1	1	2	2
15	1/4	1/4	1/2	1/2	1/2	1/2	1	1	1	1	2
20	1/8	1/4	1/4	1/4	1/2	1/2	1/2	1/2	1/2	1	1
30	1/15	1/8	1/4	1/4	1/4	1/4	1/2	1/2	1/2	1/2	1

Camera shutter speed in seconds

Table 6: Camera shutter speeds in stroboscopic mode

16. Technical Data

Battery types	Recycling times		Number of flashes min. / max.
	M-Mode	A-TTL-Modes	
High-power, alkaline-manganese	10 sec.	0.1 . . 10 sec.	100 / 3000
Lithium	11 sec.	0.1 . . . 11 sec.	200 / 5000
NiCad 700 mAh	5 sec.	0.1 . . . 5 sec.	60 / 1200
NiMh 1200 mAh	5 sec.	0.1 . . . 5 sec.	100 / /2000
Power Pack P 40	5 sec.	0.1 . . . 5 sec.	160 / 3200
Power Grip G 15/16 with alk.-mang. batt.	10 sec.	0.1 . . . 10 sec.	210 / 4200
Power Grip G 15/16 with NiCad batt. 1800 mAh	5 sec.	0.1 . . . 5 sec.	160 / 3200

Table 7: Recycling times and number of flashes with different battery types

16. Technical Data

Guide numbers at ISO 100/21°: see Table 4

12 auto apertures at ISO 100/21°:

f/1, f/1.4, f/2, f/2.8, f/4, f/5.6, f/8, f/11, f/16, f/22, f/32, f/45

Flash durations: • approx. 1/200...1/20,000 sec. in A and TTL modes
• approx. 1/200 sec. in M mode at full light output

Sensor measuring angle: approx. 25°

Colour temperature: approx. 5600 K

Film speed: ISO 6 to ISO 6400

Synchronisation: low-voltage ignition

Number of flashes p. battery charge: 60 at full light output

Swivel/tilt range and lock-in positions of zoom reflector:

upwards: 60° 75° 90°

downwards: -5° -13°

anti-clockwise 75° 90°

clockwise 75° 90° 180°

Dimensions (w x h x d), approx. 83 x 82 x 123 mm

Weight with SCA adapter and batteries: approx. 490 g

Included:

Flashgun, Standard Foot 301 (not with „Sets“), cover plate (not with „Sets“), operating instructions, operating instructions for SCA 300/3000 Adapters.

Flashgun Sets are supplied with the corresponding SCA adapter instead of the Standard Foot 301 and cover plate.

17. Optional extras

 **Malfunctions and damage caused to the Mecablitz due to the use of accessories from other manufacturers are not covered by our guarantee!**

- Bounce diffuser 40-73 (Item No. 0004073) to soften harsh shadows by indirect illumination.
- Camera bracket 40-36/2 (Item No. 0004036) to attach the flashgun at the side of the camera.
- Chargers 700...749 to charge the NiCad batteries loaded in the grip.

703 Great Britain	120/240 V	Item No. 0000703
705 New Zealand	240 V	Item No. 0000705
706 Korea	120/220 V	Item No. 0000706
708 USA	120/220 V	Item No. 0000708
709 Europe	120/220 V	Item No. 0000709
722 Australia	240 V	Item No. 0000722
741 Canada	120 V	Item No. 0000741
744 South Africa	220/250 V	Item No. 0000744
747 Cyprus	120/240 V	Item No. 0000747
- Colour filter set 40-32 (Item No. 0004032) for the main reflector, to produce colour effects.
- In-car battery charger A 16 for cars (Item No. 0000116)
Permits batteries to be charged from a car's 12 V cigarette lighter socket.
- In-car connecting cable A 17 (Item No. 0000117)
for battery charger B 28
- Light reducing filter set 40-76 (Item No. 0004076)
for the main reflector, to reduce the emitted amount of light.
- Mecalux 11 (Item No. 0000011)
Slave triggering unit for delay-free, remote firing of auxiliary flashguns. Responds to a flash triggered from the camera or to an infrared light beam. Does not require any batteries.
- Mecalux holder 60-26 (Item No. 0006026)
to fix the Mecalux 11 on the Power Grips G 15 and G 16.

17. Optional extras

- Power Grip G 15 for the SCA 300 System (Item No. 0000015)
Converts your compact flashgun into a handle-mount flashgun.
- Power Grip G 16 for the SCA 3000 System (Item No. 0000016)
Converts your compact flashgun into a handle-mount flashgun.
 - Synch cable SCA 3000 A (Item No. 0033005)
Cable with red light module, from Power Grip G 16 to camera.
 - Connecting cable SCA 300 A (Item No. 0009305)
 - Wrist strap 32-27 (Item No. 0003227)
for Power Grips G 15 and G 16
 - Case T 35 (Item No. 0000635)
to transport the flashgun with Power Grip.
- SCA Adapter System 300
For flash operation with system cameras. See separate Operating Instructions.
- SCA Adapter System 3000
For flash operation with system cameras involving digital transmission of the SCA functions. Features extended functions compared with the SCA 300 System. See separate Operating Instructions.
- Slave Adapter 3080 (Item No. 0033080)
for cordless TTL flash control of 40 MZ-... flash units
- Synch cable for Standard Foot 301:
Connecting cable 36-50 (Item No. 0003650)
Coiled connecting cable 36-52 (1.2 m) (Item No. 0003652)
Extension cable 60-54 (5 m) (Item No. 0006054)
- Synch cable SCA 3007 A (Item No. 0033007)
with red light module for remote off-camera flash control and for use of the camera bracket with SCA 3000 adapter.
- Synch cable SCA 307 (Item No. 0009307)
for remote off-camera flash control, or for use of the camera bracket with SCA 300 adapter.

18. Troubleshooting hints

No display in "ON" switch position.

Brief movement of the "ON" switch in the direction of "OFF" without overcoming the click stop enables the unit to change over to stand-by mode (display off) even though the switch is still in "ON" position.

Remedy: The unit is switched on again by normal actuation of the switch to the OFF setting, followed by "ON", or simply by pressing the "PLUS" key.

Flashing operating mode symbols

First of all check if the mecablitz is locked, and if the operating mode selector is correctly positioned.

Meaningless information

Should the LC display indicate meaningless information or should the flashgun not work properly in the individual modes, then proceed as follows:

- Switch off the flashgun by its main switch.
- Remove the batteries.
- Switch on the flashgun for approximately 1 second and then switch it off again.
- Reload the used or new batteries.

 **Lithium batteries feature an overload protection which prevents them from becoming overheated. The overload circuit responds to extreme loads (numerous flashes within a short period). In such an event the recycling time is considerably lengthened. Switch off the flashgun and allow the batteries to cool down.**

A flashing battery warning signal with only moderately warm lithium batteries indicates that the batteries have become exhausted.

18. Troubleshooting hints

Battery warning indicator

A flashing battery warning display indicates that the batteries are exhausted*.

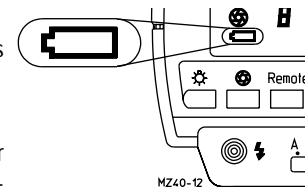

Remedy: Should the battery warning indicator continue to flash even after the batteries have been exchanged, then switch off the flashgun with the main switch ①. Open the battery compartment cover and remove the batteries. Switch on the flashgun by its main switch ① for approx. 1 second, and then switch it off again. Reload the new batteries, and the battery warning indicator will cease to flash.

* Please also refer to ch. 2, p. 9

Alphabetical index

- A**
AF measuring beam, 47
Automatic cut-out, 50
Auto mode, 44
- B**
Batteries, 7, 8
Battery warning indicator, 9, 63
Bounce flash, 20
- C**
Camera shutter speeds, 36, 57
Colour effects, 21
Contrast differences, 31
Cordless TTL operation, 23
Correct exposure indicator, 46
- D**
Distance in m or ft, 51
- E**
Easy Mode, 14
Exposure corrections, 52
Exposure o.k., 46
Exposure readings, 12
- F**
Fill-in flash, 37
Flash durations, 33, 53, 59
Flash frequency, 31, 34, 57
Flash programs, 40, 54
- I**
Indirect flash, 20
- K**
Key function, 49
- L**
Light reducing filter, 61
Locking, 49
- M**
Manual flash mode, 18
Metz TTL remote operation, 23
Modelling light, 48
Motion studies, 34
- O**
Opening shadows, 37
Optional extras, 60
- P**
Partial light output levels, 31 ff
Program storing, 42
- R**
Rapid mode, 48
Recycle times, 6, 7, 31, 58
Reflective surfaces, 20
Remote control, 23
Remote TTL operation, 23
- S**
SCA adapters, 10, 11, 61
Service menu, 51
Signal for flash readiness 46
Slave address, 29
Stroboscopic mode, 34
Swivelling of flash head, 19, 20
Swivelling of reflector, 19, 20
Synch connection, 11
Synch cables, 11
- T**
Troubleshooting hints, 61
TTL flash mode, 12
- U**
User programs, 40 ff
- W**
Wide-angle diffuser, 45
Winder mode, 30
Working apertures, 15
- Z**
Zoom reflector, 43