

Mamiya M645

Instructions

www.ianbfoto.com

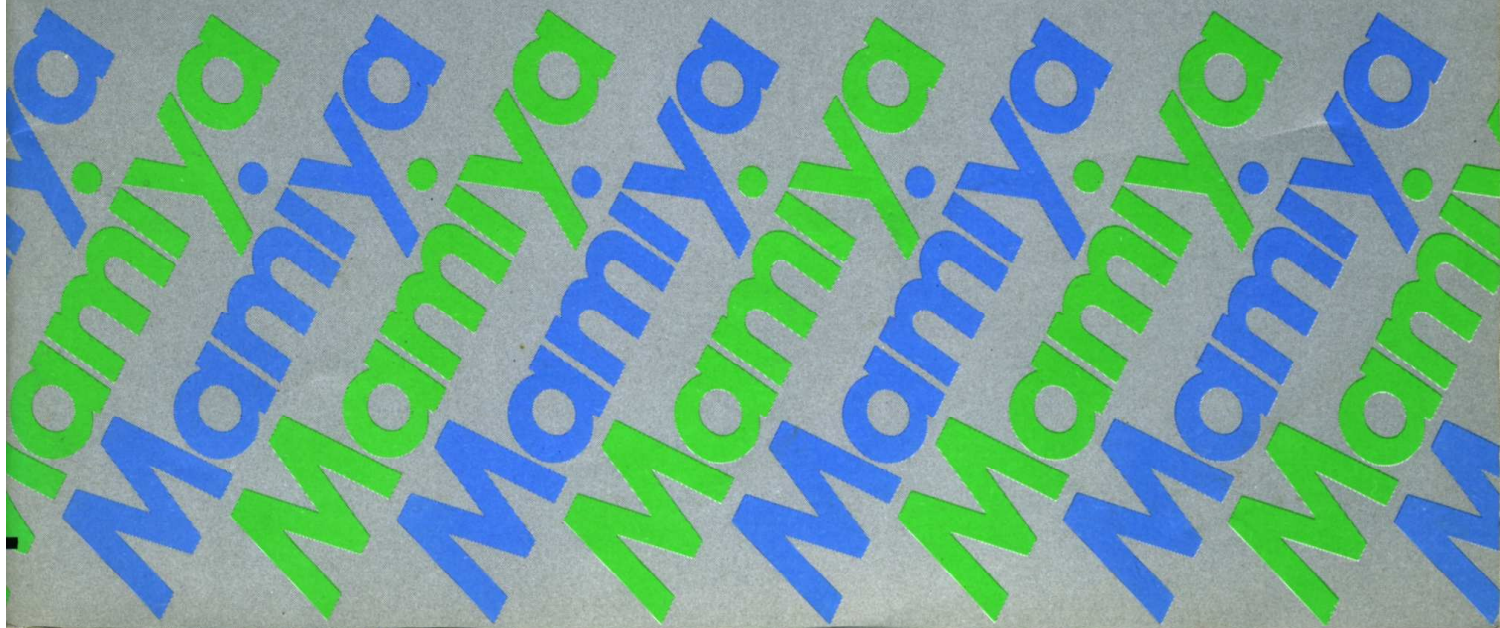

The Mamiya M645 is a newly developed 6×4.5cm SLR which is a result of Mamiya's technology and experience as a leading manufacturer of professional cameras. The M645 is designed to introduce the world of large-negative quality to camera users who are accustomed to the easy handling and compactness of 35mm SLR's.

Every care has been taken to assure that your Mamiya M645 will provide you with years of trouble-free service. However, to avoid possible mishandling, be sure to carefully read this instruction manual before using your new camera.

CONTENTS

Special Features of the Mamiya M645	3	Using the Waist-Level Finder S	44
Specifications	5	Depth-of-Field	48
Names and Functions of Parts	7	Using Flash	49
Testing to See if the Camera Functions Properly	16	Multiple-Exposures	50
Interchanging Lenses	17	Infrared Photography	50
Interchanging Finders	18	Mirror Lock-up	51
Focusing Screens	20	Tripod Socket	52
Inserting a Battery	21	Time Exposures	52
Battery Check	22	Interchanging the Film Advance Knob	53
Film Loading	23	The Mamiya Moving Coil Electronic Shutter	55
Film advancing	27		
Shutter Speed Dial	27	Trouble-Shooting	56
Aperture Ring/Stop-down Operation	28	Precautions	57
Focusing	29	Care of the Camera	58
Shutter Release and Film Transport Mechanism	30		
Unloading Film	31	Mamiya-Sekor C Lenses	59
The Neck Strap	32	Depth-of-Field Table	62
Holding the Camera	32	Accessories	63
Using the PD Prism Finder S	35	System Chart for Mamiya M645	73
Using the CdS Prism Finder	39		

Special Features of the Mamiya M645

The Mamiya M645 is a 6 × 4.5cm large-negative SLR that is both extremely versatile and compact.

1. Large-Negative Quality

The 6 × 4.5cm format offers approximately 3 times more area than the 35mm format. Moreover, unlike the 6 × 6cm square negative, there is little waste of the negative area. For beautiful color enlargements everytime, the 6 × 4.5cm format is the ideal format.

2. Compact Design

Despite the large-negative it produces, the Mamiya M645 is designed to handle as easily as a 35mm SLR. Its compact size and light weight are perfectly suited for the action photographer. It fits so well into one's hands that it becomes an extension of his reflexes.

3. Mamiya's Moving Coil Electronic Shutter

Mamiya has developed a revolutionary Moving Coil Electronically Controlled Shutter for the Mamiya M645. Electrical consumption of this new shutter is approximately 1/10 that of previous electronic shutters. Furthermore, consumption remains constant regardless of the shutter speed being used. In addition to accuracy, long battery life is assured by this new shutter.

4. Large, Bright Viewfinder

It becomes easy to catch the peak of action when looking through the large, bright viewfinder. Because of the Mamiya M645's automatic diaphragm and quick-return mirror, the viewfinder never grows dim. It is always bright, ready for the next photograph.

5. Interchangeable Finders

● Lightweight, dual-function Waist-Level Finder S

A compact and lightweight finder which opens and closes with a single touch, the Waist-Level Finder S is ideal for copying, close-ups, low and high angle pictures, and working in dim light. Additionally, it is instantly convertible to an eye-level sports finder which accurately shows the fields for the 80, 110, 150, and 210mm lenses, allowing one to easily follow the quickest action.

● Prism Finder

The Prism Finder is well-suited for action photography. Whether the vertical or horizontal format is utilized, focusing and following action is as easy as on a 35mm SLR.

● PD Prism Finder

The PD Prism Finder employs silicon cells for full-aperture, center-weighted readings. It is your assurance that every negative will be properly exposed.

3

www.ianbfoto.com

● CdS Prism Finder with built-in meter

Accurate through-the-lens exposure measurement is possible with the CdS Prism Finder which couples to the aperture of the lens and indicates the proper shutter speed to set on the camera.

6. Flatness of the Film Plane

Developed through Mamiya's long experience as a manufacturer of 120/220 roll-film cameras, the Roll-Film Inserts for the Mamiya M645 keep the film perfectly flat for edge-to-edge sharpness. Inserts are available for 120 or 220 roll-film.

7. Multi-Coated Lenses

Mamiya-Sekor lenses have achieved world-renown as professional lenses of exceptional contrast, high resolution, clear definition, and excellent color balance. All the lenses for the Mamiya M645, from wide-angle to telephoto, have been multi-coated to maintain their high standard of performance even under adverse lighting.

8. Unlimited Scope

A full range of accessories are available for the Mamiya M645 to assist the photographer in capturing virtually any type of image. Accessories include hand grips, interchangeable focusing screens, and auto extension rings

complete with meter coupling.

● Multiple-Exposure Provision

Merely lowering the multiple-exposure lever allows the photographer to take as many multiple-exposures as he wishes. During multiple-exposures, the exposure counter does not move.

● Mirror Lock-Up

The Mamiya M645 is designed to have minimal mirror shock; nevertheless, when it is necessary to completely eliminate vibrations, all you have to do is lock the mirror in the up position. To do so, simply lower the mirror lock-up lever. Mirror lock-up provision makes close-up and telephoto photography possible even at slow shutter speeds.

● Two Shutter Release Buttons

The Mamiya M645 is equipped with two ideally located shutter release buttons, so that regardless of how you hold the camera, there is always a release button at your finger tips.

4

Specifications

● Camera Body

Camera Type:

6 × 4.5cm electronic focal-plane shutter SLR.

Film Type:

120 roll-film for 15 exposures,
220 roll-film for 30 exposures

Standard Lenses:

Mamiya-Sekor C (multi-coated)
80mm f/1.9, automatic diaphragm,
with meter coupler, 67mm filter size
Mamiya-Sekor C (multi-coated)
80mm f/2.8, automatic diaphragm,
with meter coupler, 58mm filter size

Lens Mount:

Mamiya M645 bayonet mount

Shutter:

B, 8—1/500 sec.
Moving Coil Electronic Focal-Plane Shutter,
FP and X (1/60 sec.) synchronization,
Shutter release lock provision

Battery Type:

One 6V silver-oxide battery
(Eveready 544, UCAR 544, Mallory PX28)

Focusing Method:

Each Mamiya-Sekor lens is equipped with its own
helicoid focusing mount

Focusing Screen:

Microprism center spot (standard focusing screen),
surrounding area is matte, with Fresnel lens, focus-
ing screen interchangeable, 94% of the picture area
visible

Mirror:

Instant return, with mirror lock-up provision

Film Transport:

Film advance knob equipped with crank, film trans-
ported with single turn of film advance crank

Exposure Counter:

Progressive type, automatic reset, automatic
changeover with insertion of 120/220 roll-film inserts

Battery Check:

Depressing B.C. button illuminates green L.E.D. if
battery condition is satisfactory.

Multiple-Exposure:

Lowering multiple-exposure lever makes multiple-
exposures possible; exposure counter does not
move during multiple-exposures.

5

● Interchangeable Finders

Prism Finder:

The image in the Prism Finder is right-side up, lat-
erally correct, and moves in the correct direction;
magnification of 0.74X with the standard lens at in-
finity; built-on hot-shoe; comes with eyecup.

PD Prism Finder S:

Prism Finder with built-in silicon cell, through-the-
lens, full-aperture, center-weighted metering; 7
LED's visible in the viewfinder for correct or com-
pensated exposure; with 100 ASA and f/1.9 lens,
meter coupling range of EV -1.15 — +18 (f/1.9,
8 sec. — f/22, 1/500 sec.); with f/2.8 lens, EV 0 — 18
(f/2.8, 8 sec. — f/22, 1/500 sec.); camera body bat-
tery serves as power source; other features same as
Prism Finder.

CdS Prism Finder:

Prism Finder with CdS through-the-lens, full-ape-
ture, center-weighted metering; zero method with
indicator needle; couples to aperture and shutter
speed manually set; power source, one 1.5V silver
oxide battery (Eveready S-76 or equivalent); with
100 ASA and f/1.9 lens, meter coupling range of
EV 2.85 — 17 (f/1.9, 1/2 sec. — f/16, 1/500 sec.);
with f/2.8 lens, EV 4 — 18 (f/2.8, 1/2 sec. — f/22,
1/500 sec.); other features same as Prism Finder.

Waist-Level Finder S:

Opens and closes with a single touch; magnification
of 1.3X (w/standard lens at infinity); diopter correc-
tion lenses interchangeable with standard magnifier;
built-in sports finder shows field for standard lens
and accepts a mask for 110, 150, and 210mm lenses,
all fields showing approximately 80% of the picture-
taking area.

Dimensions and Weight:

(width, height, depth, w/80mm f/1.9 lens)

(w/Waist-Level Finder S)	(w/1.9 lens)	(w/2.8 lens)
3-29/32" × 3-15/16" × 6-9/16" (99.3 × 100 × 166.5mm)	54.7 oz (1550 g)	48.9 oz (1385 g)
(w/Prism Finder)		
3-29/32" × 4-27/32" × 6-9/16" (99.3 × 122.7 × 166.5mm)	61.6 oz (1745 g)	55.7 oz (1580 g)
(w/PD Prism Finder S)		
3-29/32" × 4-29/32" × 6-9/16" (99.3 × 124.7 × 166.5mm)	65.8 oz (1865 g)	60.0 oz (1700 g)
(w/CdS Prism Finder)		
3-29/32" × 4-29/32" × 6-9/16" (99.3 × 124.7 × 166.5mm)	66.5 oz (1885 g)	60.7 oz (1720 g)
Depth w/80mm f/2.8 lens; 6-1/16" (154mm)		

6

Names and Functions of Parts (1)

Focusing screen

Five different types are available.

Focusing screen lug

Mounting guide pin for finder

Fits into the finder opening.

Alignment dot

Alignment reference point for mounting lens.

Shutter release button (front)

Built-in safety lock, locks release button if film has not been advanced. Equipped with cable release socket.

Shutter release lock ring

Turn lock ring and align with red dot to simultaneously lock both shutter release buttons. To unlock, align with white dot.

Battery check lamp

If the green battery check lamp glows when the battery check button on the opposite side is depressed, battery condition is good.

Flash sync terminals

With safety cover, only the cover of the sync terminal being used is removed.

Neck strap lug

Shutter speed alignment mark

Do not set dial to the \odot position unless using the PD Prism Finder.

Lens release button

Push in and simultaneously turn the lens counterclockwise to remove.

Mirror

Never touch the surface of the mirror.

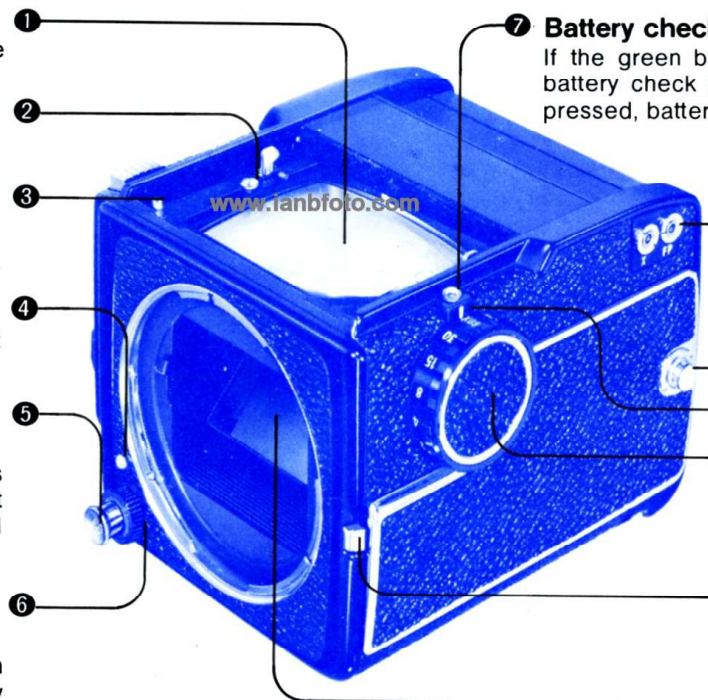

7

Back cover latch

While pushing in on the memo clip, simultaneously move the back cover latch in the direction of the arrow to open camera back.

Back cover

When closing, apply pressure firmly and evenly in the area of the back cover latch.

Memo clip

Holds the film box top as a reminder.

Exposure counter window

Automatic changeover upon insertion of 120 or 220 film insert. Goes up to 15 with 120 film and up to 30 with 220 film.

Battery check button

When depressed, the battery check lamp on the opposite side illuminates. Used to check the condition of the battery.

Shutter release button (upper)

Mirror lock-up lever

Push backward to lock mirror in the up position.

Film advance knob

One complete turn cocks shutter and advances film.

Film advance crank

Pull out to use.

Multiple-exposure lever

Move the multiple-exposure lever to the "multi" position for multiple-exposures or to release the shutter when there is no film in the camera.

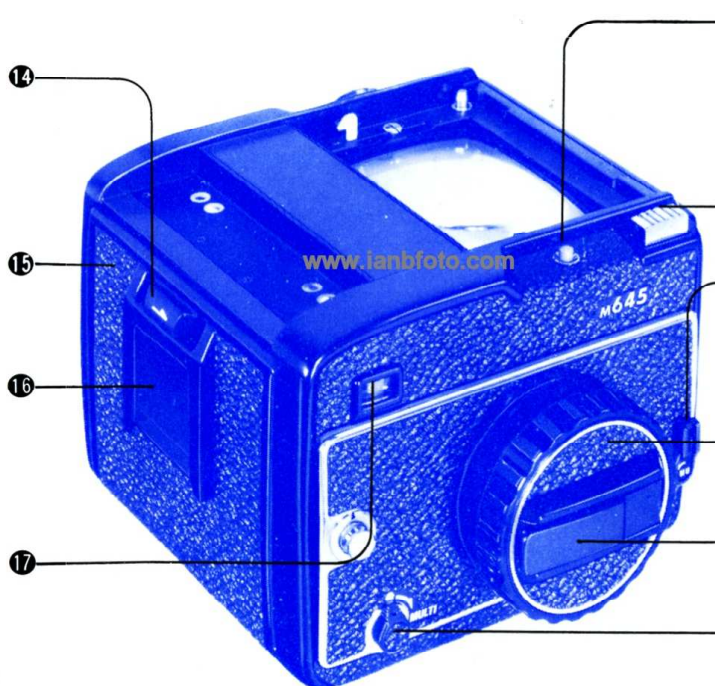

8

Names and Functions of Parts (2)

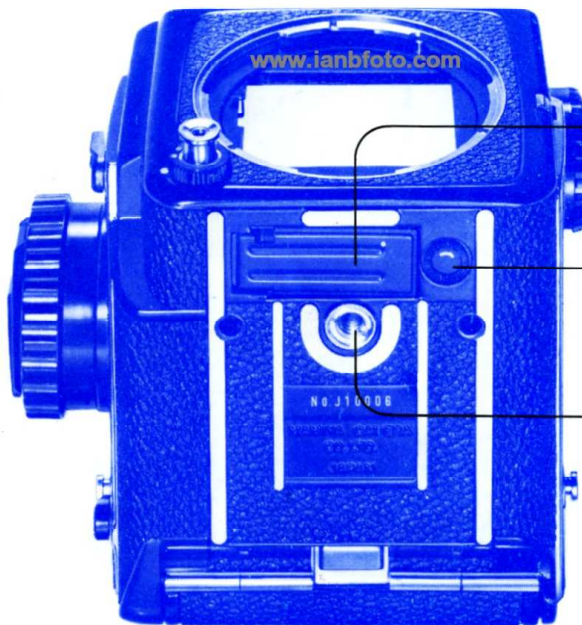

24 Battery chamber cover

Insert one 6V silver-oxide battery into the battery chamber.

25 Battery chamber opening button

Twist in the direction of the arrow to open battery chamber cover.

26 Tripod socket

1/4 inch tripod socket. To convert to a 3/8 inch socket, first remove the small screw in the base of the socket. Next, remove the inner socket by turning counterclockwise with a coin.



28 Focusing ring

29 Distance scale

30 Depth-of-field scale

Alignment dot

Align with matching alignment dot on camera body for rapid lens mounting.

32 Aperture ring

33 Exposure meter coupler

Couples the aperture ring to the PD Prism Finder.

A.M. Lever

Automatic diaphragm operation when "A" appears in the window. Diaphragm stopped down to preselected aperture when "M" appears in window.

Names and Functions of Parts (3)

Roll-Film Insert

(120 and 220 roll-film inserts are available)

Start Mark

After aligning the start mark on the film's leader paper with this mark, the roll-film insert is ready for insertion into the camera.

Release latch

After squeezing in on both sides of release latch, the roll-film insert can be pulled out of camera.

Spool clip

Pull out and lower spool clip to insert or remove film spools.

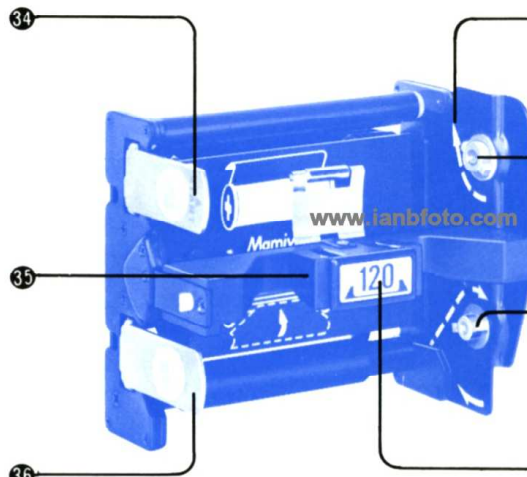

37 Leader paper guide marks

Indicates the direction leader paper is to follow.

38 Film spool stud

Place film spool on film spool stud so that the black side of the leader paper faces up.

39 Take-up spool stud

Attach empty spool to take-up spool stud and insert the tip of the leader paper into the spool slot.

40 Film type index (120 or 220)

Insert roll-film insert into camera with the film type index upright. If the film type index is upside down, roll-film insert will not fit into the camera.

11

Prism Finder



Eyecup

Attach by sliding into the grooves of the eyepiece.

Diopter correction lens retainer ring

Remove by unscrewing in a counterclockwise direction. After inserting correction lens, replace retainer ring.

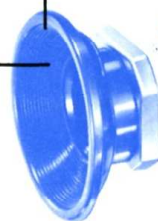

Hot-shoe (with safety cover)

Automatically fires cordless flash units when the shutter release button is depressed.

Eyepiece

Accessories such as eyecup, magnifier, and angle finder can be attached.

Finder release button

Turn clockwise until it stops, push in, and the finder can be lifted off the camera body.

12

Names and Functions of Parts (4)

PD Prism Finder S

(Detailed Instructions on pp. 42-45)

Aperture ring coupling pin

Couples to the exposure meter coupler on the aperture ring.

Hot-shoe

(with safety cover)

Automatically fires cordless flash units when the shutter release button is depressed.

Eyepiece

Accepts accessories such as eyecup, magnifier, and angle finder.

Eyecup

Attach by sliding into the grooves of the eyepiece.

Diopter correction lens retainer ring

Remove by unscrewing in a counterclockwise direction. After inserting correction lens, replace retainer ring

Meter switch

Pushing in on this switch when the finder is attached to the camera will turn on the meter and a LED in the finder will light up. Even if you release pressure from the meter switch, the meter will remain on for approximately 15 seconds and then automatically turn off to conserve electricity.

Shutter speed dial

ASA window

ASA dial

Pull out and then turn.

Finder release button

Turn clockwise until it stops, push in, and the finder can be lifted off the camera body.

13

Names and Functions of Parts (5)

CdS Prism Finder

(Detailed instructions on pp. 46-50)

Aperture ring coupling pin

Couples to the exposure meter coupler on the aperture ring.

Hot-shoe (with safety cover)

Automatically fires cordless flash units when the shutter release button is depressed.

Eyepiece

Accepts accessories such as eyecup, magnifier, and angle finder.

Eyecup

Attach by sliding into the grooves of the eyepiece.

Diopter correction lens retainer ring

Remove by unscrewing in a counterclockwise direction. After inserting correction lens, replace retainer ring.

Shutter Speed Dial

Be sure to manually set the shutter speed dial of the camera body to the speed indicated by this dial.

Power switch

Set to OFF when the meter is not being used.

ASA dial

Pull out and then turn.

ASA window

Finder release button

Turn clockwise until it stops, push in, and the finder can be lifted off the camera body.

Battery chamber cover

Remove the cover with a coin and insert a 1.5V battery into the chamber.

14

Waist-Level Finder S (For detailed instructions, see pp.51-53)

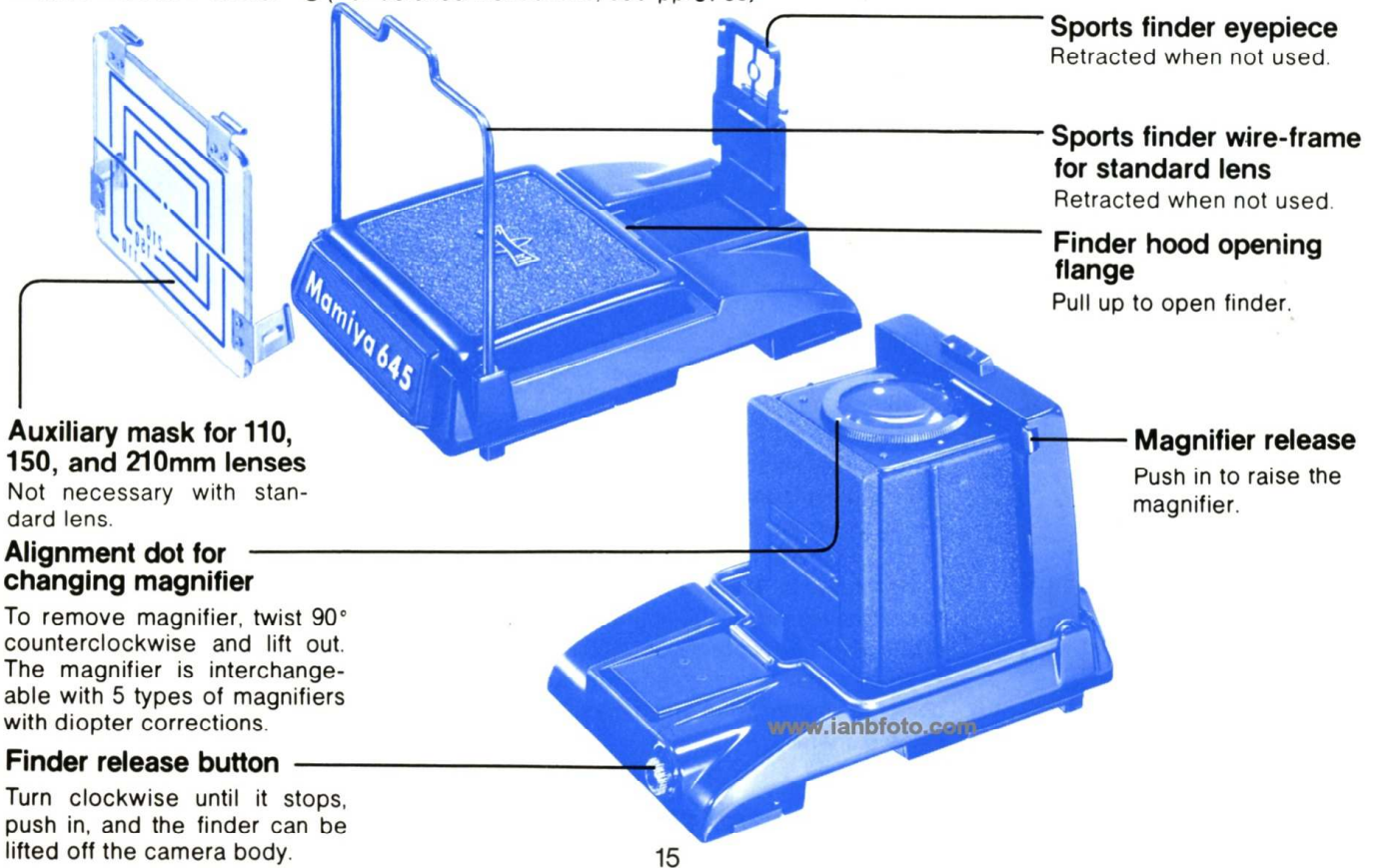

Testing to See if the Camera Functions Properly

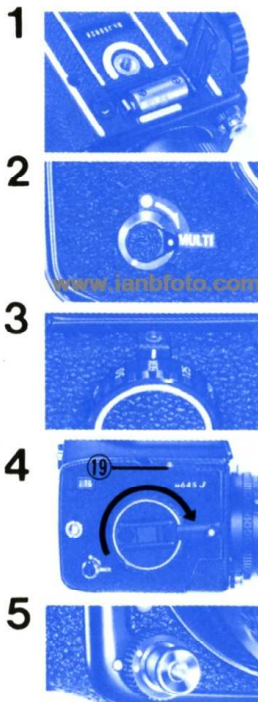

To release the shutter when there is no film in the camera, proceed as follows. (For detailed instructions on particular points, refer to the page number shown in parentheses.)

1. Insert a battery into the camera (p.22)
2. Set the multiple-exposure lever to "MULTI" (p.57)
(If you have just purchased the camera and the vinyl tube is still on the take-up spool, there is no need to move the multiple-exposure lever.)
3. Set the shutter speed dial to any shutter speed other than the  red mark (p.28)
4. Turn the film advance knob until it stops.
5. Align the shutter release lock ring with the white dot and release the shutter (p.31)

When ready to load the camera with film, return the multiple-exposure lever to its normal position. If this is not done, the film will not advance.

If the shutter is released without a battery in the camera, the mirror will lock in the up position. To return the mirror to its normal position, depress the battery check button (19) as far as it will go.

If the shutter is released with the shutter speed dial set to the red  position, the mirror will lock in the up position. To lower the mirror, turn the shutter speed dial in either direction (B or 1/500 sec.).

At times it may be necessary to rotate the film advance knob two full turns to cock the shutter when an empty take-up spool (without its original vinyl tube) is in the camera.

Interchanging Lenses

www.ianbfoto.com

● Removing the Body Cap

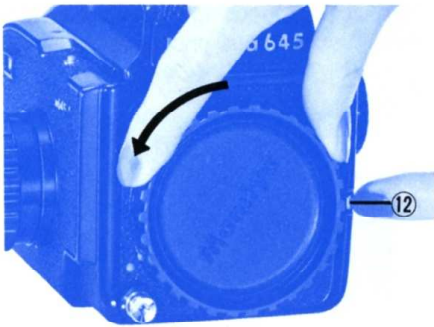

While depressing the lens release button (12), turn body cap counterclockwise until the red dots are aligned and lift out.

● Attaching Lenses

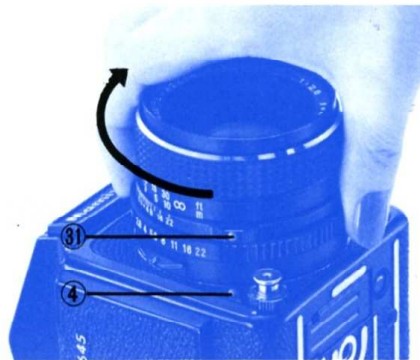

While aligning the two alignment dots (31 & 4), insert lens into camera body. Then twist lens clockwise until it clicks and locks into place.

● Removing Lenses

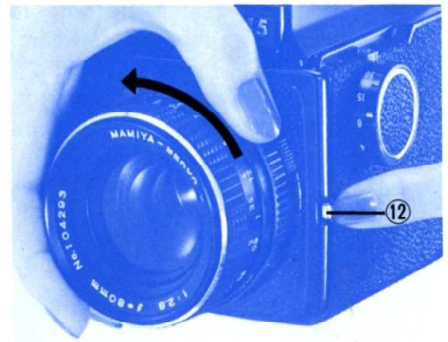

While depressing the lens release button (12), grasp the part of the lens barrel that has the depth-of-field scale (30) and alignment dot (31), and twist the lens counterclockwise until it stops. Then lift out.

17

Interchanging Finders

★After removing a lens, be sure to place caps on both the lens and camera body.

★Never touch the surface of the mirror.

★After removing a lens, it is recommended to lock the shutter release button by setting the shutter release lock ring (6) in order to avoid accidentally releasing a cocked shutter when placing the camera body face down on a table.

All finders are interchanged in the same manner.

Prior to attaching the finder to the camera, confirm that the white dot on the finder release button is pointing upward.

If the white dot on the button is aligned with the white dot on the finder, by depressing the button and removing your finger from it, the white dot on the button will automatically point upward. In this condition, the button cannot be depressed; consequently, the finder will not be accidentally detached from the camera.

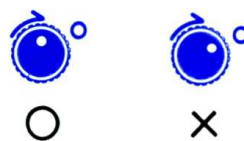

● Attaching Finders



Place the rear part of the finder on the camera body while holding the front part of the finder slightly upward. Slide the rear part forward until it stops and gently lower the front part of the finder on to the camera body. It will then lock into place.

18

● Removing Finders



1. Turn the finder release button clockwise until it stops (about 60°). Then you will be able to push in on the release button.

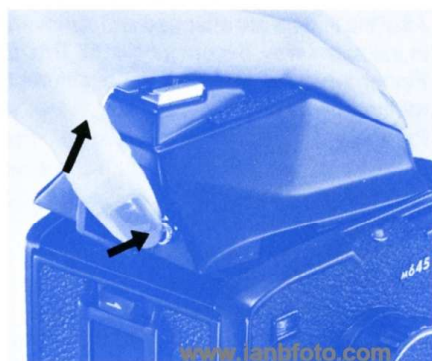

2. While pushing in on the release button with your thumb, lift the finder off the camera body.

Precaution:

Do not leave both white dots aligned by turning the button while the finder is attached to the camera. The finder may become detached when the button is occasionally depressed, possibly causing damage.

If you depress the button to point the white dot upward while the finder is attached to the camera, be sure to depress the finder against the camera body; otherwise the finder will not be locked into place.

19

Focusing Screens

● Interchanging Focusing Screens

The focusing screens are readily interchangeable. Five different focusing screens are available to meet various photographic needs.



Remove the finder, grasp the focusing screen lug (2), pull up, and lift out. To replace screen, gently insert and lightly push it in on both sides until it stops.

★ Since the rear surface of the screen is made of plastic, be careful not to scratch it when interchanging screens.

20

Inserting a Battery



The Mamiya M645 uses one 6V silver-oxide battery 4SR44 (Eveready No. 544, UCAR 544, Mallory PX28 or equivalent) or alkaline battery 4LR44.

1. Pull the battery chamber cover latch (24) slightly toward the lens and the chamber cover will open.

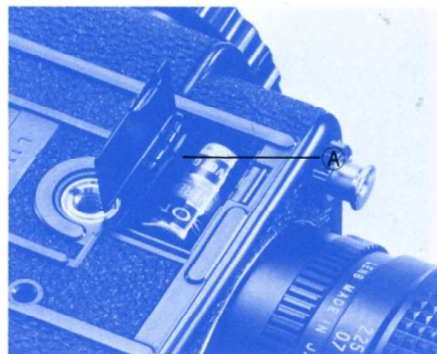

2. Next, insert the battery, exercising caution that the \pm poles match those shown on the diagram of the chamber. Battery removal will be simplified if the battery removal ribbon (A) passes under and over the battery.

CAUTION:

1. Carefully wipe the contacts of the battery before inserting it into the chamber. Failure to do so could result in poor electrical contact and consequent erratic functioning of the camera.
2. When the camera is not used for a long period of time, remove the battery and store it in a cool, dry place.
3. When replacing a battery, properly dispose of the used battery immediately as it is potentially dangerous. The batteries are explosive and should therefore never be thrown into a fire.
4. A battery that is not used for a long period, even if it is properly stored in a dry, cool place, may lose some of its charge. Consequently, check its condition after replacing it in the camera with the battery check button.

21

Battery Check

This camera is designed for use with either silver oxide or alkaline batteries. Although both types offer adequate performance, silver oxide batteries last much longer.

IMPORTANT: When using the PD Prism Finder, make it a point to use silver oxide batteries when available (in this instance, battery life is shortened if alkaline batteries are used).



When the battery check button (19), located above the film advance knob) is depressed, the battery check lamp (7, located above the shutter speed dial) illuminates. If the battery check lamp fails to go on, it is time to replace the battery.

★ When the battery is completely exhausted, the opened shutter will not close. At this time, **if the battery check button is pushed all the way down as far as it will go, the shutter will then close.**

22

Film Loading

● Loading the Film



1. While gently pushing in on the memo clip (16), move the back cover latch (14) in the direction of the arrow and the camera back cover will open.

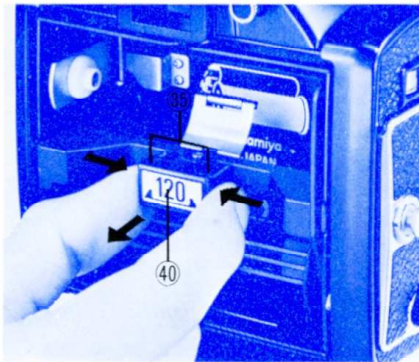

2. While squeezing in on both sides of the release latch (35), pull the roll-film insert out of the camera body. Place the film insert on a table making sure that the film type index (40) is not upside down. Then pull out and lower the spool clips found on the left-hand side.

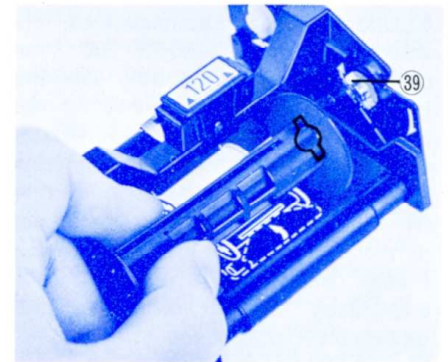

3. Align the right-hand side of an empty spool with the lower spool stud (39). Then return the spool clip (36) to its former position, making sure that the left-hand side of the spool is properly held by the spool clip.

23

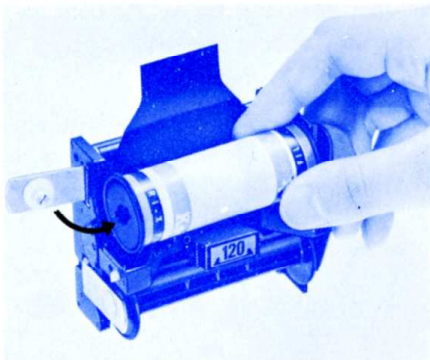

4. In the same manner insert a roll of film in the upper compartment.

5. Make sure that the black side of the leader paper faces up.

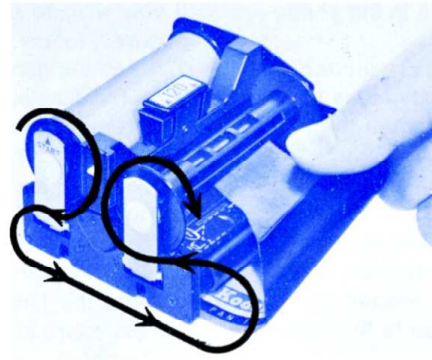

6. Gently pull out some of the leader paper, pulling it over and around the pressure plate. Then insert the tip of the leader paper into the slot of the take-up spool.

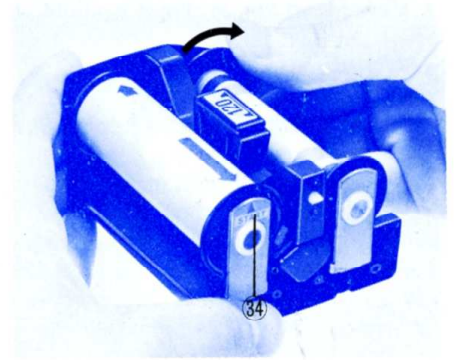

7. Gently rotate the take-up spool in the direction of the arrow until the start mark of the film is aligned with the start mark on the spool clip (34).

★ The above step is to be completed before the roll-film insert is placed into the camera.

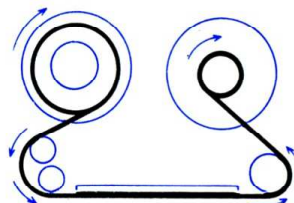

24

★ Never load film in direct sunlight. Load it in the shade or in your own shadow.

★ Roll-film inserts for both 120 and 220 film are loaded in the same manner. The exposure counter advances to 15 when the 120 film insert is used, and to 30 when the 220 film insert is used.

Make absolutely sure to match the film insert with the film type being used. If the wrong insert is used, the correct film plane will not be maintained and optimum sharpness will not be achieved. Moreover, if 120 film is used in the 220 film insert, there is the danger of the leader paper getting caught in the shutter causing damage to the camera.

★ Before placing the film insert into the camera, make sure the leader paper on the take-up spool is flat and lies evenly between the two edges of the take-up spool. The take-up spool should be wound sufficiently tight to make it impossible for the leader paper to ride over the edge of the take-up spool.

★ Always align the start marks of the film and spool clip before placing the film insert into the camera. (If the start marks are aligned within the camera with the aid of the film advance knob, the first frame will not be correctly positioned.)

● Using Roll-Film Designed for Six Exposures

If you wish to use roll-film designed for six 6 × 6cm exposures, follow the procedure outlined below.

1. Load the film in a 120 film insert and use in the normal way. The film will take 7 exposures.

2. After 7 exposures have been taken, set the shutter speed dial to 1/500 sec., wind the film advance knob and release the shutter 4 more times (the exposure counter will indicate "11").

3. Wind the film advance knob once again so that the exposure counter indicates "12", open the back cover, and remove the film insert. (Do not release the shutter when the exposure counter indicates "12".)

4. Completely wind the remaining leader paper around the film take-up spool.

★ If the film in the camera is completely wound onto the take-up spool, there is the danger of the tip of the leader paper getting caught in the shutter curtain and damaging the camera.

25

● Insertion of the Film Insert



1. Grasp both sides of the release latch (35) of the film insert, making sure that the film type index (40) is not upside down, and place the film insert straight into the camera body. After the film insert has completely entered the camera body, let go of the release latch.

2. Press in on the outer edges of the release latch (indicated by the arrows in the photograph above) and the roll-film insert will lock into place. (If the roll-film insert does not go all the way in on the right-hand side, turn the film advance knob slightly while pushing in on the right side of the film insert.)

3. After insertion has been completed, securely close the camera back cover.

★ If the film advance knob moves slightly from the time the film insert is placed into the camera to the time the back cover is closed, there will be no ill effects. However, if the film advance knob moves too much, the first frame will be fogged.

● Memo Clip



The memo clip found on the camera back cover can be used to hold the film box top.

★ The memo clip also doubles as a safety lock to prevent the camera back from accidentally opening. If excessively thick paper is placed in the memo clip, it will no longer simultaneously serve as a safety lock.

26

Film Advancing

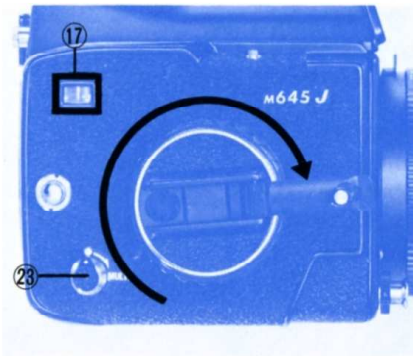

1. After the film has been placed into the camera make sure that the multiple-exposure lever (23) is aligned with the white dot and not with the word "MULTI".
2. Wind the film advance knob until it stops and the number 1 will appear in the exposure counter window (17). The shutter is now cocked and the camera is ready for the first exposure.

Shutter Speed Dial

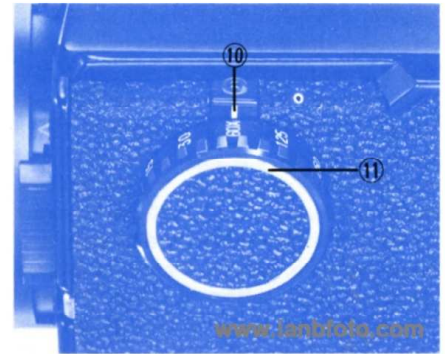

Align the desired shutter speed with the shutter speed alignment mark (10) by turning the shutter speed dial (11) in either direction.

- (a) The figures on the shutter speed dial represent the denominator of a fraction. (Thus, 30 equals 1/30 sec.).
- (b) The letter B represents BULB. The shutter will remain open as long as the shutter release button is depressed when the shutter speed dial is set to B.
- (c) The red 60X represents the highest permissible shutter speed for electronic flash synchronization.
- (d) The red \odot mark is the position the

27

Aperture Ring/Stop-down Operation

shutter speed dial is set to when the AE Prism Finder or PD Prism Finder is used.

★ If the shutter is released with the shutter speed dial set to the \odot position and the AE or PD Prism Finder is not attached to the camera, the shutter will lock in the open position. **If the camera is left in this condition, the battery will lose its power within several hours, so rectify the situation at once.** (Moving the shutter speed dial to B or 1/500 sec. will close the shutter.)

★ Set the shutter speed dial only to the click-stop positions. Using an intermediate position will result in inaccurate exposures.



Set the desired f/stop on the aperture ring (32) by aligning the f/number with the red reference dot (A). (The aperture ring has a click stop for each f/stop. In-between clicks can also be used.)

● AM Lever

1. For normal use, set the AM (Auto-Manual) lever (27) so that "A" appears in the window. When this is done, the aperture is always open, closing only when the shutter is released.

2. When you wish to preview the depth-of-field, move the AM lever to the "M" position.

Focusing



1. While looking through the viewfinder eyepiece, adjust the focusing ring (28) until the most important subject appears sharp and clear.

2. The central microprism grid is useful for rapid and accurate focusing as the slightest focusing adjustment will snap the image in and out of focus.

3. As a further aid, a fine focusing collar surrounds the microprism grid.

Since the Mamiya M645 is an SLR, the photographer always sees in the viewfinder exactly what will appear on the film, regardless of the lens or accessory being used. Moreover, simply moving the AM lever to the M position will allow one to preview the depth-of-field and appearance of out-of-focus images.

★ As an accessory, Mamiya offers diopter correction lenses which can be attached to the prism finders, and diopter lenses for the waist-level finder. Near and farsighted persons will find these accessories useful for obtaining accurate focus.

29

Shutter Release and Film Transport Mechanism

● Shutter Release Lock Ring

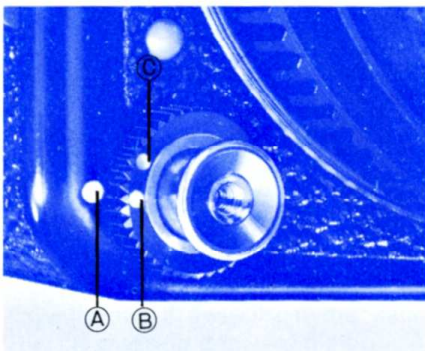

The shutter release button is equipped with a lock ring to prevent accidental release of the shutter.

1. When you wish to release the shutter, turn the shutter release lock ring so that the white dot (B) is aligned with the dot (A) on the camera body.

2. Aligning the red dot (C) of the shutter release lock ring with the dot on the camera body will simultaneously lock both shutter release buttons.



1. When releasing the shutter, you may use either the front or upper shutter release button.

2. After releasing the shutter, the film advance knob is automatically unlocked, making it possible to transport the film to the next frame.

Please notice the following points regarding the film transport mechanism:

★ A built-in safety lock prevents the shutter from being released if the film advance knob is not fully wound or if the exposure counter is between S and 1.

★ After the fixed number of exposures has been taken (15 or 30), the shutter release button automatically locks.

★ If the film is advanced while depressing the shutter release button, the shutter will be released at the instant the film is fully advanced. Do not attempt to take pictures in this manner as a degree of camera shake is inevitable.

★ If the PD Prism Finder is not attached to the camera body and the shutter is released with the shutter speed dial set to the \odot position, the mirror will lock in the raised position and the shutter will remain open. (Moving the shutter speed dial to B or 1/500 sec. will lower the mirror and close the shutter.)

★ Use of the multiple-exposure lever is explained on page 50.

★ The front shutter release button is threaded to accept cable releases or self-timers.

★ Do not strongly depress the upper shutter release button while simultaneously advancing the film. If this is done, the film advance automatic stop mechanism will be disengaged, and the film will advance even during the operation of the shutter. Moreover, the

30

Unloading Film

mirror may lock in the up position, which results in rapid depletion of the battery. Should the mirror lock in the raised position for the above reason, first continue to rotate the film advance knob until it stops (after the fixed number of exposures (15 or 30) have been taken, the film advance knob should be rotated more than one full turn), then lower and raise the mirror lock-up lever, and the mirror will return to its normal position, simultaneously terminating needless electrical consumption.

1. After the fixed number of exposures have been taken (15 for 120, 30 for 220), the shutter release button will lock. At that time, wind the film advance knob until the leader paper is completely wound onto the take-up spool. (When winding is complete, resistance will no longer be felt on the film advance knob.)

2. Open the back cover, remove the roll-film insert and the exposure counter will reset to S (Start). **The exposure counter will not reset to S if the insert is not removed.**

3. Remove the film from the film insert, exercising care that the film does not loosen, and seal it.

The Neck Strap

● Attaching to Camera

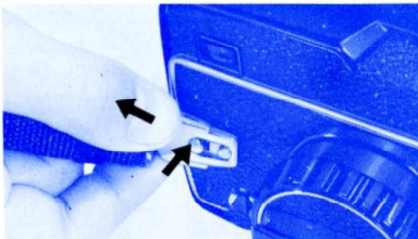

Place the neck strap fastener over the neck strap lug on the camera body and gently pull it away from the camera while pressing it toward the body until it clicks and locks in place.

● Removing from Camera



While pushing in on the rear blade of the neck strap fastener with your thumb, slide it forward and remove.

Methods of holding the camera securely

● Eye Level Operation

No matter how carefully one focuses the camera, if there is camera movement during the instant the shutter is released, sharp pictures are unlikely. To eliminate camera movement, care must be taken regarding the method of holding the camera and releasing the shutter.



● Waist-Level Operation



● Hand Grips

When hand-holding the camera with the waist-level finder attached, adjust the length of the neck strap to take up all slack and support the camera against the body. As accessories, Mamiya offers a selection of hand grips which not only help to eliminate camera-shake, but are also convenient for carrying the camera.



Using the PD Prism Finder S (1)

● Special Features

1. The PD Prism Finder is an eye-level finder with a built-in silicon photo diode exposure meter and electronic shutter control circuit.
2. The PD Prism Finder offers complete coupling of the lens aperture, shutter speed, and film speed (ASA).
3. Seven LED's are built into the viewfinder system. A green LED indicates correct exposure and red LED's indicate over, under, and compensated exposure.
4. The built-in meter covers a broad range, is highly accurate even in dim light, and has a rapid response because it utilizes silicon photo diodes.

● Specifications

Viewfinder: 0.74 magnification with standard lens at infinity, built-on hot-shoe, comes with eyecup.

Metering System: Center-weighted, through-the-lens, full-aperture metering. One green and six red LED's built into the viewfinder system for correct exposure determination.

Meter coupling Range: (with f/1.9 lens and 100 ASA film)
EV -1.15 - +18
(f/1.9, 8 sec. - f/22, 1/500 sec.)
(with f/2.8 lens and 100 ASA film)
EV 0 - 18
(f/2.8, 8 sec. - f/22, 1/500 sec.)

Shutter Speed Range: 1/1000 - 8 sec.

ASA Range: 25 - 6400
(aperture coupling in the entire range)

When this finder is attached to the Mamiya M645, the available shutter speed range is from 1/500 sec. to 8 secs.

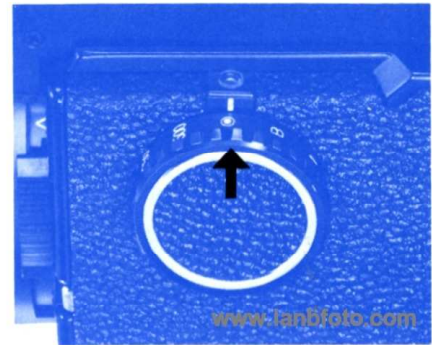

Since the PD Prism Finder utilizes the battery in the camera body, a timer is incorporated into the meter switch of the PD Prism Finder to prevent unnecessary electrical consumption.

1. Set the camera body shutter speed dial to the PD Prism Finder position ⊙ located between B and 1/500 sec.

If the shutter speed dial is set to a position other than ⊙, the PD Finder and camera body will not be electrically connected. Consequently, the viewfinder LED's will not illuminate.

35



2. Attach the PD Prism Finder to the camera body.

3. Turn the aperture ring of the lens so that the exposure meter coupler (33) of the lens and the aperture ring coupling pin (A) of the PD Finder engage.

★ **Be sure to check for proper coupling.** If the aperture ring coupling pin (A) is not properly seated in the fork of the exposure meter coupler (33), use a pen (or similar device) to push the aperture ring coupling pin into its proper position into the fork.



4. Pull out and turn the ASA dial (B) until the appropriate ASA number appears in the window.

★ **Always set the AM Lever on the lens to "A", otherwise correct metered exposure cannot be obtained.**

ASA	DIN
6400	(39)
(5000)	• (38)
(4000)	• (37)
3200	(36)
(2500)	• (35)
(2000)	• (34)
1600	(33)
(1250)	• (32)
(1000)	• (31)
800	(30)
(650)	• (29)
(500)	• (28)
400	(27)
(320)	• (26)
(250)	• (25)
200	(24)
(160)	• (23)
(125)	• (22)
100	(21)
(80)	• (20)
(64)	• (19)
50	(18)
(40)	• (17)
(32)	• (16)
25	(15)

36

Using the PD Prism Finder S (2)

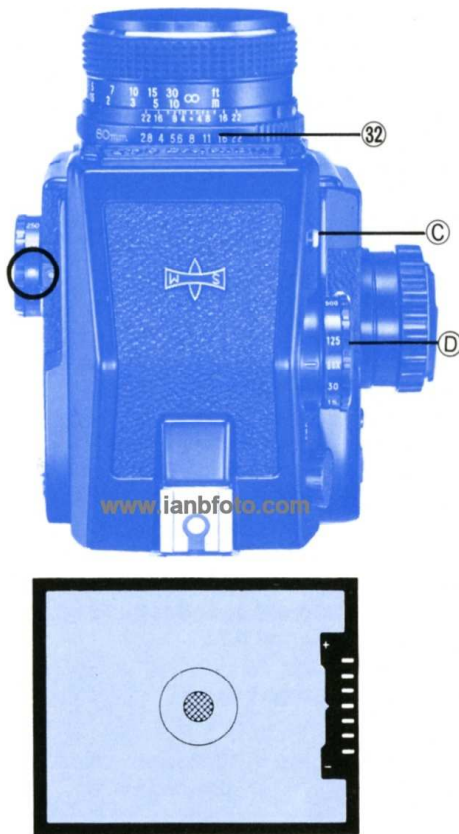

5. Push in and release the meter switch (C) to turn on the meter. With the meter on and while looking through the viewfinder, adjust the aperture ring (32) or shutter speed dial (D) until the central (green) LED in the right-hand side LED panel illuminates, indicating correct exposure.

The meter circuit remains on as long as the meter switch is depressed. After releasing your finger from the switch, it will stay on approximately 15 seconds longer, then the meter will automatically turn off to conserve electrical consumption.

★ If two LED's illuminate simultaneously, make fine adjustments with the aperture ring until the central green LED appears the brightest.

★ Remember to adjust the shutter speed with the PD finder shutter speed dial and to keep the camera body shutter speed dial set to ☉.

★ The shutter speed dial has click-stops at full one speed intervals and cannot be used at intermediate positions. Although the aperture ring has click-stops at one stop intervals, intermediate positions may also be used.

★ This camera can be used at up to its maximum shutter speed of 1/500 sec. Although the PD Prism Finder dial can be set to 1/1000 sec., this shutter speed does not exist in this camera. To avoid error, the shutter speed dial of the PD Prism Finder has a strong click stop at the 1/1000 sec. position to enable the user to tell by touch alone, without any need to remove his eye from the viewfinder, when he is changing from the adjacent 1/500 sec. or 8 sec. shutter speeds to 1/1000 sec.

37

Using the PD Prism Finder S (3)

● Exposure Compensation

The LED Panel incorporated into the PD Prism Finder simplifies exposure compensation, assuring perfect exposures everytime. Each LED represents a full stop increment and plus and minus signs are indicated within the viewfinder to assist in compensating. The uppermost LED represents three or more stops overexposure, and the lowermost LED represents three or more stops underexposure.

● Compensation Hints

1. For strongly back-lit subjects outdoors, set the exposure to +1 (the red LED directly above the green one).
2. To photograph a person indoors, seated next to a window and strongly back-lit, set exposure to +2.
3. When photographing interiors, to compensate for the bright interior lights, set exposure to +1 or +2.
4. When copying white documents, set exposure to +2. If a standard gray card is used to determine exposure, no correction is necessary.

5. When photographing a brightly lit subject against a dark background, such as a night club performer, set exposure to -1 or -2.

6. Brightly lit night scenes, such as city streets, are usually rendered most naturally with the correct exposure (green LED).

7. When photographing extremely dark subjects (e.g. close-up of a black cat), set exposure to -1.

★ The exposure compensation or LED panel can also be used to increase the ASA range to 3 - 51200. For example, with the ASA dial set to 25, instead of using the green LED for correct exposure, use the +3 LED when using ASA 3 film.

★ Since the upper and lowermost LED's represent 3 or more stops difference from the central (green) LED, whenever compensating by 3 stops, first adjust the aperture or shutter speed for 2 stops of compensation and then move the aperture ring or shutter speed dial one more click stop for 3 stops of compensation.

★ In order to obtain more accurate exposures, observe the same cautions as with the AE Prism Finder. Refer to page 41, "Correct Exposure Measurement."

Using the CdS Prism Finder (1)

● Special Features

1. The CdS Prism Finder is an eye-level finder with a built-in CdS exposure meter for accurate exposure measurement.
2. It couples to the aperture when attached to the camera.
3. An exposure meter indicator needle is visible in the viewfinder to indicate correct exposure.

● Specifications

Viewfinder: Unreversed, laterally correct image; 0.74× magnification with standard 80mm lens at infinity; built-in hot-shoe and equipped with an eyecup.

Metering System: Center-weight TTL full-aperture, zero-method via indicator needle.

Meter Coupling Range: (with f/1.9 lens and 100 ASA film)
EV 2.85 — 17

(f/1.9, 1/2 sec. — f/16, 1/500 sec.)

(with f/2.8 lens and 100 ASA film)

EV 4 — 18

(f/2.8, 1/2 sec. — f/22, 1/500 sec.)

Shutter Speed Range: 1/1000 — 1 sec.

ASA Range: 25 — 6400

(aperture coupling in the entire range)

Power Source: One 1.5 V silver oxide battery

● Inserting the Battery



This finder utilizes a 1.5 V silver oxide battery (Eveready S-76, Mallory MS-76 or equivalent) as the power source.

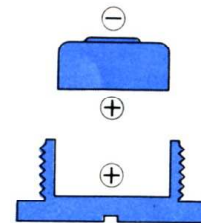

39

Using the CdS Prism Finder (2)

● Method of Use

1. Remove the battery chamber cover by rotating it counterclockwise with the aid of a coin.

2. The underside of the battery chamber cover bears a + mark. Be sure to have the + marks of battery and chamber cover face each other as the battery is inserted. Then securely retighten battery chamber cover.

★ Wipe battery with a soft cloth before inserting into battery chamber, as a soiled battery may fail to make, or maintain, proper contact.

★ When the finder is not used for a long period of time, remove the battery and store it in a cool, dry place.

★ Never throw used batteries into a fire, or attempt to charge a battery.



1. Attach the CdS Prism Finder to the camera body.

2. Turn the aperture ring of the lens so that the exposure meter coupler (33) and aperture ring coupling pin (A) of the CdS Prism Finder engage.

★ Be sure to check for proper coupling. If the aperture ring coupling pin (A) is not properly seated in the fork of the exposure meter coupler (33), use a pen (or similar device) to push the aperture ring coupling pin into its proper position into the fork.

★ Always set the AM Lever on the lens to "A", otherwise correct exposure cannot be obtained.

40

Using the CdS Prism Finder (2)

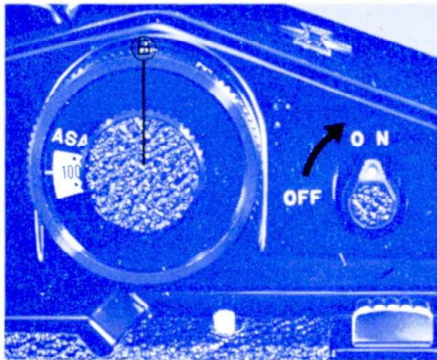

3. Set the meter of the CdS Prism Finder to the correct ASA. To do so, pull out and rotate the ASA dial (B) so that the appropriate ASA number appears in the window, aligned with the index mark.

4. Turn the exposure meter switch to ON.

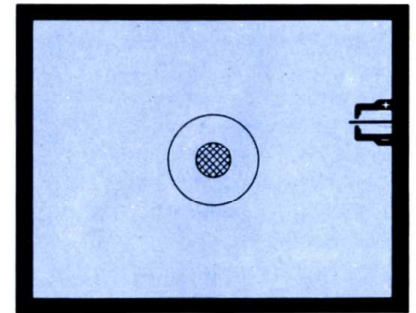

5. Set the shutter speed dial on the camera body to the desired speed, and then set the shutter speed dial of the CdS Prism Finder to the same speed.

(Examples of recommended shutter speeds to use with 100 ASA film would be 1/250, or 1/125 sec. outdoors on a sunny day, 1/125 or 1/60 sec. outdoors on a cloudy day, and 1/30 sec. when working indoors.)

6. To set the correct exposure, rotate the aperture ring until the exposure meter indicator needle visible in the viewfinder is centered between the two brackets visible on the right-hand side of the focusing screen.

41

Using the CdS Prism Finder (3)

If the indicator needle cannot be centered even after rotating the aperture ring as far as it will go, the exposure must be adjusted by rotating the CdS Prism Finder shutter speed dial. If the indicator needle is too high, set the shutter speed dial to a shorter ("faster") speed; if too low, set to a longer ("slower") speed. After adjusting the shutter speed dial of the CdS Prism Finder, if the indicator needle is slightly off-center, make final adjustments with the aperture ring.

Whenever changing the setting of the shutter speed dial of the CdS Prism Finder to adjust for exposure, do not forget to set the shutter speed dial of the camera body to the same setting.

7. After the above steps have been completed (centering of the indicator needle), exposure setting should be correct, and the picture may be taken.

● Aperture Priority Method

1. When desiring to set the aperture first, set the aperture ring to the desired f/stop, and then adjust for exposure by rotating the shutter speed dial of the finder until the indicator needle is centered between the brackets.

2. Check the setting of the finder shutter speed dial, and **set the same setting on the shutter speed dial of the camera.**

★ When adjusting for exposure with the CdS Prism Finder shutter speed dial, do not use any intermediate positions, but always set the dial to a click-stop. If the indicator needle cannot be perfectly centered with the shutter speed dial at a click-stop position, make final adjustments with the aperture ring.

The brackets visible in the viewfinder not only indicate correct exposure, but are also notched to indicate ± 2 f/stops (see diagram) to simplify exposure compensation for unusual lighting. When the exposure meter switch is set to OFF, the indicator needle rests at the bottom position.

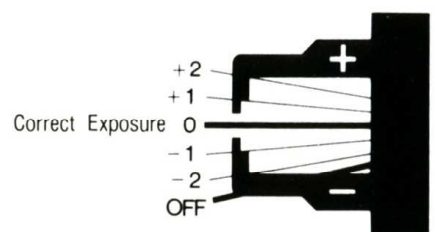

42

Using the CdS Prism Finder (3)

● Meter Coupling Range

The range of usable shutter speeds varies in accordance with the film speed (ASA). As the shutter speeds shown in the shaded area of the diagram below are beyond the range of the meter, the shutter speed dial is provided with a safety lock to prevent one from entering the non-usable zone. For example, it can be seen from the diagram that 1/8 sec. is in the non-usable zone when using film rated at 800 ASA (or higher); consequently, when the ASA dial of the CdS Finder is set to 800, the shutter speed dial cannot be set to 1/8 sec.

★Do not meter with the CdS Prism Finder dial set at 1/1000 sec. because the shutter speed dial of this camera goes only to 1/500 sec.

★To conserve battery power, keep the exposure meter switch set to OFF whenever the meter is not in use. Even when forgetting to set the switch to OFF, whenever the CdS Prism Finder is removed from the camera, the exposure meter is automatically switched off because of the small safety switch built into the bottom of the finder.

★To obtain optimum results, follow the same precautions outlined for the PD Prism Finder (see "Correct Exposure Measurement", p.38).

Usable Shutter Speeds (unshaded area)

ASA	Shutter Speeds (sec.)											
	1	1/2	1/4	1/8	1/15	1/30	1/60	1/125	1/250	1/500	1/1000	
25												
50												
100												
200												
400												
800												
1600												
3200												
6400												

43

Using the Waist-level Finder S (1)

● Opening the Finder Hood

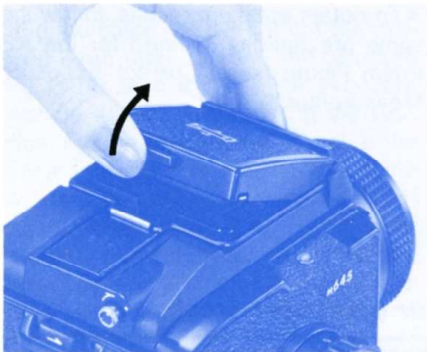

Pull up on the finder hood opening flange to open the finder.

● Closing the Finder Hood

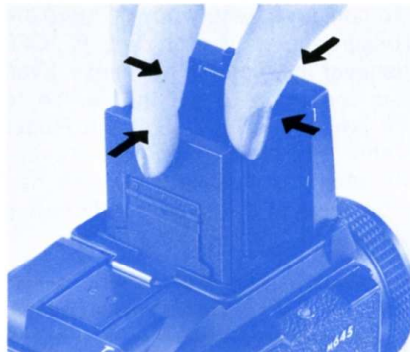

First, push in on the sides; next, push the front cover and back together to fold the finder.

● Raising the Magnifier

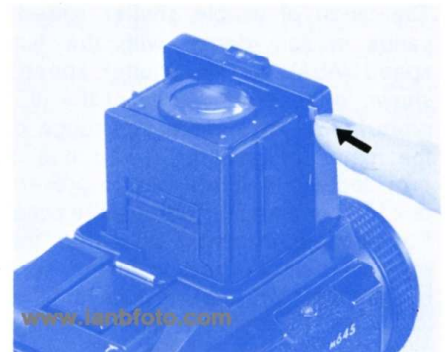

Push in on the magnifier release button to raise the magnifier.

44

● Lowering the Magnifier

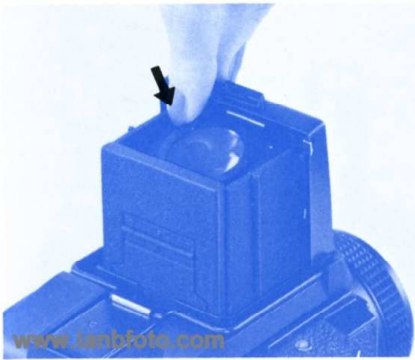

To lower, push down on the edge of the magnifier board until it locks into place.

● Interchanging Magnifiers

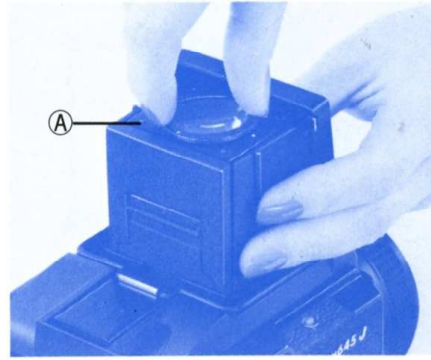

Removing the Magnifier

While holding the finder side panels with the left hand so that the magnifier board (A) is not lowered, grasp the edge of the magnifier with the fingers of the right hand and twist counterclockwise to remove.

Attaching a Magnifier

Align the white dots of the magnifier and magnifier board; drop magnifier into magnifier board, and twist clockwise until magnifier clicks and locks into place.

★ In addition to the standard magnifier (–1.5 diopters), magnifiers of +2, +1, 0, –2, and –3 diopters are available for near and farsighted users.

The standard –1.5 diopter magnifier is designed for users, whether eyeglass wearers or not, that have no trouble seeing a subject 2.5 ft. (70cm) away clearly. For those who have difficulty seeing clearly at such a distance, or for those who wish to remove their eyeglasses in order to see the entire focusing screen field, please use a diopter lens which is available as an optional accessory. However, before making a purchase, try the diopter lens at your Mamiya dealer to make sure it matches your eye.

45

Using the Waist-level Finder S (2)

● Using the Sports Finder

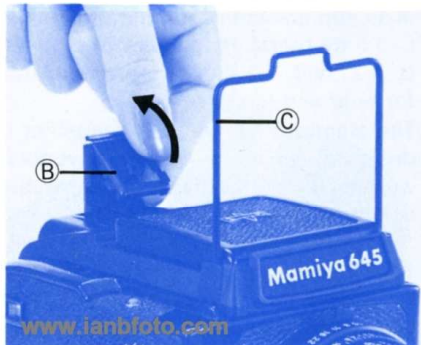

With Waist-Level Finder S in the closed position, first raise the sports finder eyepiece (B) to a vertical position. The eyepiece sight folds into the eyepiece base; when lifted out of the base, the eyepiece sight will stay in a vertical position because of the eyepiece spring. Next, lift the wire-frame (C) of the sports finder.

As the Waist-Level Finder Hood can be opened even with the sports finder mask raised, focusing can be quickly and easily checked. (However, if the finder hood is first opened, the sports finder wire-frame cannot be raised.)

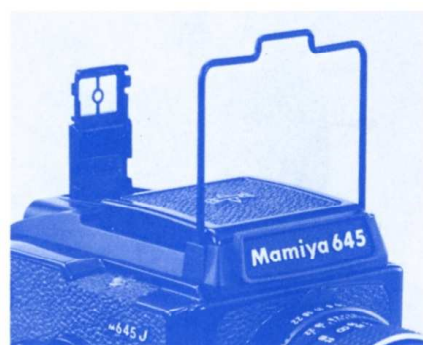

The wire-frame of the sports finder indicates the field for the 80mm lenses. When desiring to use the 110, 150, or 210mm lens, the auxiliary mask must be attached to the wire-frame. When desiring to open the Waist-Level Finder Hood, while the auxiliary mask is attached to the raised frame, first pull the bottom of the auxiliary mask out to the second notch, in order to prevent the auxiliary mask from blocking the finder hood.

● Using the Auxiliary Mask

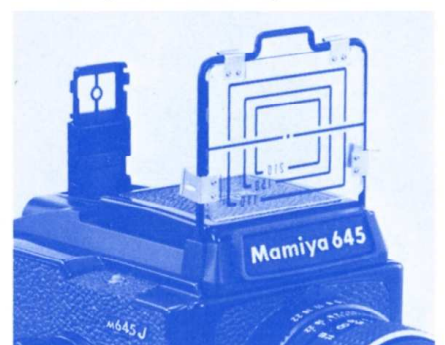

Setting the auxiliary mask to the second notch has no adverse effects on the accuracy of the indicated fields; therefore, it is perfectly acceptable to use the sports finder in this condition. Additionally, when the auxiliary mask is set to the second notch, it is also possible to lower it over the closed finder hood, although it is recommended to remove the auxiliary mask before lowering the wire-frame in order to minimize scratches on the surface of the plastic mask.

46

Advanced Technique

In order to meet every photographic need, the Mamiya M645 is embellished with a host of features. Mastery of these features will not only lead to better pictures, but will open up the doors to new photographic possibilities as well.

Depth-of-Field

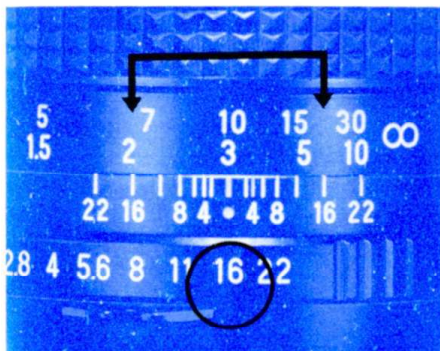

Depth-of-field refers to the total area (foreground and background) which will appear in focus (sharp). The area of sharpness (depth-of-field) depends upon the distance the lens is focused at, the f/stop (or aperture) being used, and the focal length of the lens. The area that will appear sharp can be determined in two ways:

1. Firstly, by setting the AM lever to the M (Manual) position, the depth-of-field for the aperture set on the lens can be inspected (previewed) by looking through the finder. After examination of the depth-of-field, return the AM lever to the A (Automatic) position to return the finder to its original brightness.
2. The depth-of-field can also be determined by referring to the depth-of-field scale engraved on the lens and which lies directly above the aperture ring. The f/stop numbers are engraved on both the right and left-hand sides of the center reference mark. Simply locate the f/stop (aperture) you are using and read the figures which appear above the f/stop number on the distance scale of the lens. The figure on the right-hand side of the center reference mark denotes the area farthest from the camera which will appear sharp and the left-hand figure denotes the area closest to the camera which will appear sharp.

For example, with the 80mm f/2.8 lens focused at 10ft. (3m) and the aperture ring set to f/16, the depth-of-field scale reveals that everything from about 7ft. (2m) to about 20ft. (6m) will appear sharp (see photograph).

Using Flash



1. Flash units can be attached to the camera's tripod socket or to the accessory shoe of the hand grip.

2. The Mamiya M645 has two sync terminals which are used in the following way:

(1) When using an electronic flash, plug the synchronization cord into the X terminal and set the shutter speed dial to 1/60 sec. or longer (1/30 - 8 sec.).

(2) When using FP flashbulbs, plug the cord into the FP socket and set the shutter speed dial to 1/60 sec. or shorter (1/125 - 1/500 sec.).

(3) For MF and M bulbs, use the X terminal and set the shutter speed dial to 1/30 sec. or longer for MF bulbs, and 1/15 sec. or longer for M-type bulbs.

★ The Prism and PD Prism Finder are equipped with a hot-shoe and offer cordless flash operation for flash units that have a hot-shoe contact.

★ If the flash duration of an electronic flash is longer than 1/1000 sec. (e.g. 1/600 sec.) set the shutter speed dial to 1/30 sec. (not 1/60 sec.) or longer.

★ When using flash, carefully read the instructions packed with the flashbulbs or flash unit to avoid making errors.

Precaution when Using Flash

When using the X-sync terminal of the camera body, be sure to insert the plastic safety cover into the hot-shoe, and when using the hot-shoe, be sure to insert the appropriate safety cover into the X-sync terminal. This procedure will prevent the possibility of receiving an electric shock while an electronic flash is attached and accidentally touching the terminal not being used.

Flash Synchronization Chart

Sync Terminal	Shutter Speeds												
	1/500	1/250	1/125	1/60	1/30	1/15	1/8	1/4	1/2	1	2	4	8
F P	FP Class												
X	Electronic flash												
	MF Class												
	M, FP Classes												

49

Multiple-Exposures



When the white dot of the multiple-exposure lever (23) is aligned with MULTI, the double-exposure prevention mechanism is disengaged, so that the shutter can be cocked with the film advance knob without moving the film, making multiple-exposures possible. (When making multiple-exposures, the exposure counter does not advance.)

When desiring to make a multiple-exposure, set the multiple-exposure lever to MULTI. (It can be set to MULTI either before or after the initial exposure of the multiple-exposure.) After making the initial exposure, recock the shutter with the film advance knob and then make the second (double) exposure, repeating as often as desired.

Remember to return the multiple-exposure lever to its original position upon completion of the multiple-exposure.

★ To release the shutter when there is no film in the camera, set the multiple-exposure lever to "MULTI".

Infrared Photography

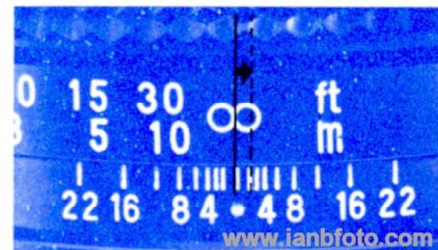

When using infrared film it is necessary to make a focusing adjustment in order to achieve accurate focus. This focusing adjustment is particularly important when:

- using non-wide-angle lenses
- taking close-ups
- shooting at wide apertures

Focusing Adjustment Procedure

1. The red dot or line on the right side of the center reference line (also red) is the infrared mark.

2. After focusing in the usual manner, check the distance on the distance scale that is aligned with the center reference mark of the lens, and then make the focusing adjustment by turning the focusing ring slightly in the direction indicated by the arrow in the accompanying photograph so that the distance just observed is aligned with the infrared mark.

★ For information regarding the proper filter and exposure, refer to the data sheet packed with the film.

Mirror Lock-up

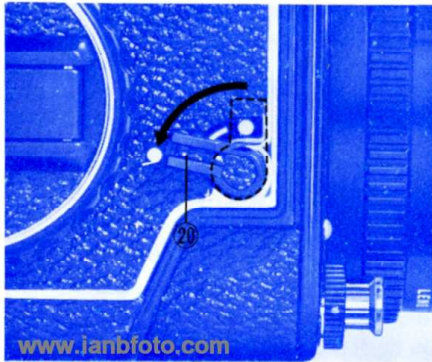

When the camera is mounted on a tripod for copy work or telephotography at long (slow) shutter speeds, the small amount of vibrations due to "mirror-bounce", which normally are of no consequence, may cause blurring of the image due to the high magnification encountered in extreme close-ups and telephotography. Mirror shock can be eliminated by locking the mirror in the up position before making the exposure.

1. To lock the mirror up, merely move the mirror lock-up lever (20) backwards, until it is horizontal (the lever may be lowered either before or after cocking the shutter).

2. With the shutter cocked, release the shutter with a cable release. After releasing the shutter, you may wind the film advance knob with the mirror still in the up position if you wish.

★ Return the mirror to its normal position immediately after completing all of your mirror lock-up photography.

★ When using the 70mm f/2.8 lens (w/between-the-lens shutter), be sure to refer to the instructions packed with the lens.

51

Tripod Socket



As a general rule of thumb for optimum sharpness, we recommend using 1/125 sec. as the minimum shutter speed for hand-held shooting. For longer exposures (1/60 sec. — 8 sec.), attach the camera to a sturdy tripod.

1. For standard tripods with a 1/4" screw, the camera may be directly attached to the tripod as it is.

2. To attach to tripods with the larger 3/8" screw, first unscrew the small screw found in the base of the camera's tripod socket by turning it counterclockwise. Next, remove the 1/4" adapter (A) by inserting a coin in the slot and turning the adapter in a counterclockwise direction. Finally, attach the camera to the 3/8" tripod.

★ If it is necessary to completely eliminate all camera movement, attach camera to a tripod, lock the mirror up, and release the shutter with a cable release.

★ When attached to the accessory Revolving Tripod Adapter, the Mamiya M645 can be instantly rotated to change from vertical to horizontal format, or vice versa.

Time Exposures

There are two methods of taking time exposures with the Mamiya M645.

1. By setting the shutter speed dial to B and using a cable release with lock provision.

2. By removing the battery from the battery chamber.

(a) Remove battery.

(b) Set the shutter speed dial to any position.

(c) Release the shutter and it will lock in the open position.

(d) Depress battery check button as far as it will go to close shutter.

52

Interchanging the Film Advance Knob

The film advance knob is interchangeable with the film

● Removing the knob

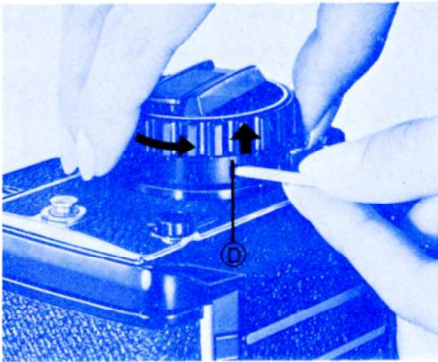

1. Rotate film advance knob until it stops.
2. While holding the release lever (D) of the knob in the up position with a small screwdriver, or suitable tool, rotate knob counterclockwise and it will disengage from camera body.

● Attaching the knob

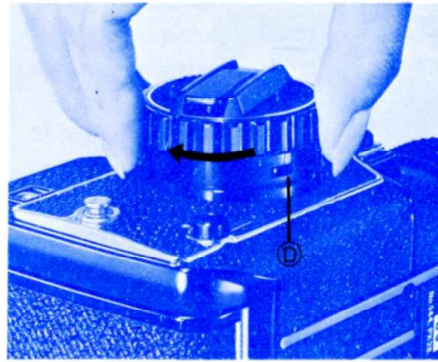

1. Rotate the film advance knob receptor of the camera body clockwise as far as it will go (the red dot (B) will then be facing upward).
2. With the release lever (D) of the knob at its lowest position, place knob against knob receptor of the camera body, rotating it clockwise approximately 20° and the knob will lock into place.

● Attaching the crank

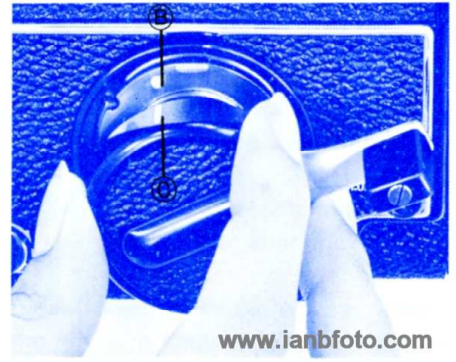

1. Align the red dot (B) of the camera body with the index line (C) on the film advance crank.
2. With red dot and index line aligned, push the film advance crank into the receptor, then twist approximately 20° clockwise while pushing in on the release lever (A), and it will lock into place.

53

advance crank which is available as an optional accessory.

● Removing the crank

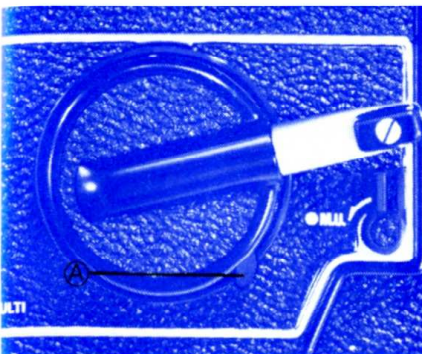

1. Rotate the film advance crank until it stops.
2. Then, rotate it counterclockwise approximately 20° while simultaneously pushing in on the release lever (A), and it will detach.

★When desiring to exchange the film advance crank or knob, first rotate it until it stops and the shutter is cocked. If this is not done, the camera body receptor [and red dot (B)] will freely rotate, making replacement difficult.

54

The Mamiya Moving Coil Electronic Shutter

The electrical consumption of Mamiya's newly developed Moving Coil Electronic Shutter is merely 1/10 that of the electro-magnetic system currently in wide use. Moreover, the consumption remains constant regardless of shutter speed with Mamiya's M. C. Shutter. Therefore, Mamiya has been able to greatly increase battery life.

Furthermore, battery performance is maintained at a high level, as indicated in the accompanying diagrams, as the moving coil condenser is normally charged keeping the battery at peak voltage. Thus, the battery is protected from drops in voltage, as when the switch is on.

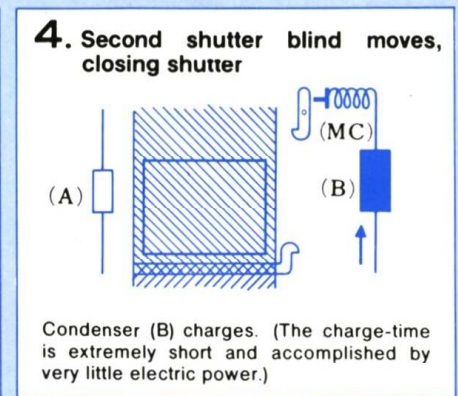
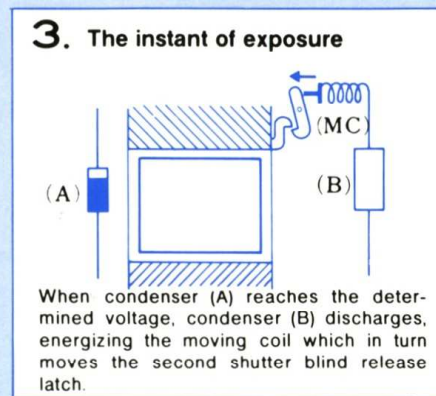
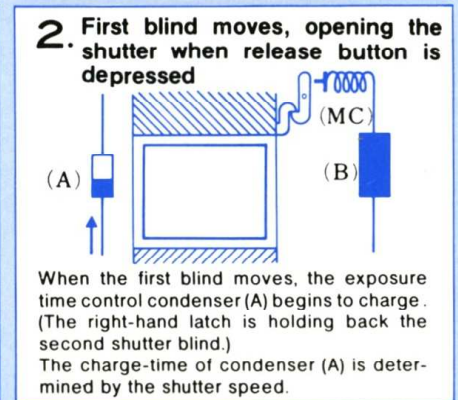
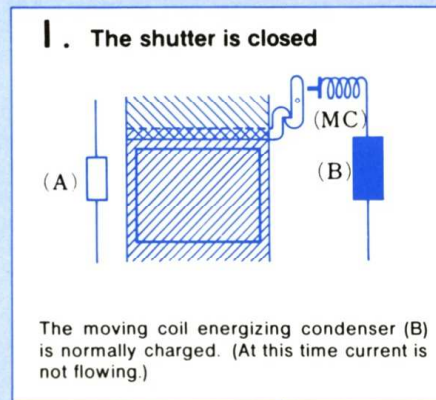

Trouble-Shooting

If your camera appears to be malfunctioning, check the list below to see whether or not you have forgotten something.

1. The shutter release button will not move.

- A) Did you unlock the shutter release button? (p.30)
- B) Did you wind the film advance knob until it stops? (p.30)

2. The mirror is locked in the up position. (Cannot see anything through the finder.)

A) Did you release the shutter without a battery in the camera? Has the battery been correctly inserted into the camera, or is it backwards? Is the correct battery type inserted into the camera?

Press the battery check button, as far as it will go, to lower mirror. (p.22)

B) Did you lower the mirror lock-up lever? If so, raise it. (p.51)

C) Did you release the shutter with the shutter speed dial set to the \odot position?

If so, move the shutter speed dial to B or 1/500 sec. (p.28)

3. The developed roll of film has 1 or 2 frames less than it should have.

A) Did you align the start marks with the film advance knob after placing the roll-film insert into the camera?

The film should always be set to the start mark before placing the film insert into the camera. (p.24)

B) Did you properly align the start marks of the film and roll-film insert?

Check the instructions once again. (p.24)

4. The PD Prism Finder's LED's do not illuminate when pressing the meter switch.

Did you set the camera's shutter speed dial to the \odot position? If not, there will be no electrical connection. (p.35)

5. You may receive an electric shock when an electronic flash is connected to the X-sync terminal and you touch the hot-shoe. Also, you may receive an electric shock when an electronic flash is attached to the hot-shoe and you touch the X-sync terminal.

As a precaution against possible shock, always keep the safety cover on the terminal when not in use (see p.49)

Precautions

Releasing the shutter with no film in the camera

The film transport mechanism has a built-in safety lock which prevents the shutter from being released after the last exposure on a roll of film, or when there is no film in the camera. Thus, when the shutter release button locks under such circumstances, do not force it. To release the shutter, merely set the multiple-exposure lever to "MULTI".

Mirror Lock-up

When the mirror is locked in the up position and the camera is outdoors there is a small possibility of sunlight entering the lens, focusing on the rubberized-cloth focal-plane shutter, and burning it to a certain degree. Although such a possibility is remote, caution is called for. Therefore, when using mirror lock-up outdoors, always return the mirror to its normal position after completing all your mirror lock-up exposures. If the interval between mirror lock-up exposures is long, lower the mirror while waiting.

The ☉ position on the Shutter Speed Dial

If the shutter is released with the shutter speed dial set to the ☉ position, the mirror will lock in the up position and the film advance knob will not move. If the camera is left in this condition, the battery will lose its power within several hours.

The ☉ position is only for use with the PD Prism Finder.

Photographing at Low Temperatures

When photographing at low temperatures, be careful of the following points to maintain camera performance.

1. Be sure to use a fresh battery.
2. When using electronic flash, set the shutter speed dial to 1/30 sec. or longer.
3. Place the camera in the outside air only during the moment of exposure.

★ When working at extremely low temperatures, it sometimes becomes impossible to wind the film advance knob after the shutter has been released because the mirror locks up. In such a case, it will become possible to wind the film advance knob if the upper shutter release button is pressed strongly as far as it will go. The mirror can then be lowered by operating the mirror lock-up lever back and forth. (If the camera is left in this condition without winding the film advance knob, the batteries will be exhausted within several hours.)

★ A battery that malfunctions at low temperatures will become usable again when it is returned to normal temperature. However, the battery should not be subjected to rapid and extreme changes of temperature, lest it grow unreliable.

57

Care of the Camera

When the camera is not used for a long period of time, remove the battery and any film from the camera. Do not store the camera at temperatures exceeding 100°F (40°C), or at temperatures less than 15°F (-10°C). Also avoid storing the camera for prolonged periods of time in a damp or salty atmosphere. (Color film should be stored at the manufacturer's recommended temperatures.)

As cameras are precision instruments, avoid shocks and rough handling.

When the camera is stored for a long time, periodically remove the camera and release the shutter several times to keep the camera in good condition.

Cleaning

Never touch the lens or mirror surfaces. Keeping a Mamiya UV or SL filter (p.63) on the lens will protect it from dust, fingerprints, and so on. If a lens needs cleaning, blow away the dust particles with a blower, and clean the lens surface with lens cleaning tissue and lens cleaner. Merely blowing dust particles off the mirror surface is sufficient — never touch it.

Periodic Check

Periodically check the camera to make sure it is in working order. This is especially so before an important photographic assignment. Check the battery, flash synchronization, mirror and shutter movement, film wind, diaphragm automation and so on. If the camera is malfunctioning, take it to the nearest authorized Mamiya Service Center for repairs. Handled with reasonable care, your Mamiya M645 should provide you with years of pleasure.

58

Mamiya-Sekor C Lenses

Mamiya-Sekor C
35mm f/3.5

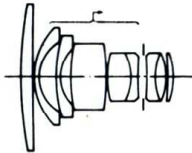

Mamiya-Sekor C
45mm f/2.8

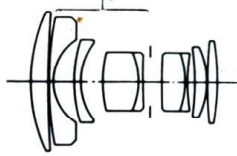

Mamiya-Sekor C
55mm f/2.8

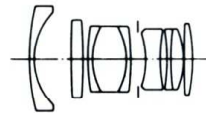

Mamiya-Sekor C
70mm f/2.8
(lens-shutter type)

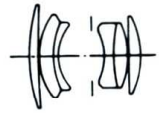

Mamiya-Sekor C
150mm f/4

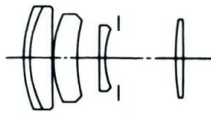

Mamiya-Sekor C
210mm f/4

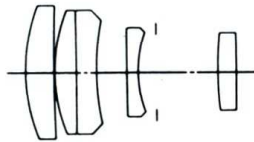

Mamiya-Sekor C
300mm f/5.6

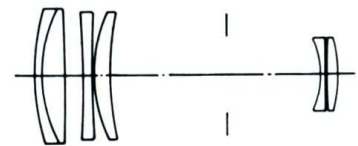

59

Mamiya-Sekor C
80mm f/1.9

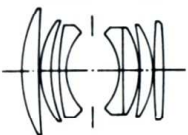

Mamiya-Sekor C
80mm f/2.8

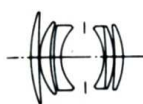

Mamiya-Sekor Macro C
80mm f/4

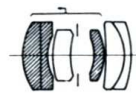

Mamiya-Sekor C
110mm f/2.8

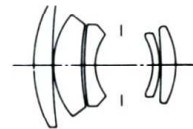

Mamiya-Sekor C **500mm f/5.6**

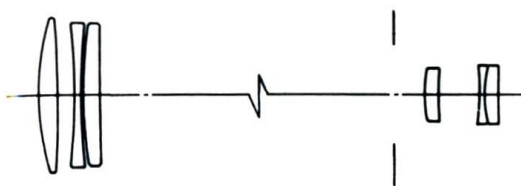

Mamiya-Sekor C Lenses

www.ianbfoto.com

The chart below gives the basic specifications of the lenses currently available for the Mamiya M645.

Mamiya-Sekor Lenses have long been established as a standard for lenses of professional calibre. Whether you are using a wide, standard, or telephoto lens, the name "Mamiya-Sekor" is your assurance that your camera is using

optics foremost in quality. In order to make the most of the intrinsic contrast, high resolution, rich color saturation, and clear definition of Mamiya-Sekor lenses, all the lenses for your camera have been multi-coated. Not only has the quality been enhanced, but flare and ghost images have been reduced to a minimal level, even when shooting

under highly unfavorable lighting. For shooting in cramped quarters, for extensive depth-of-field, dynamic perspective, and exciting panoramics, you will enjoy the wide-angle lenses. For flattering portraiture, shallow depth-of-field, sports, and candid photography, the telephoto lenses are ideal.

Lens	Optical construction	Angle of view	Minimum aperture	Diaphragm	Minimum focusing distance	Filter size	Lens hood	Length	Maximum dia.	Weight
35mm f/3.5	9 elements, 7 groups	90°	22	Automatic	1.5 ft. or 0.45m	77mm	None required	2-13/32" (61.5mm)	3-5/32" (80mm)	15.7 oz. (445g)
45mm f/2.8	9 elements, 7 groups	76°	22	Automatic	1.75ft. or 0.5m	77mm	Slip-on	3-1/16" (78mm)	3-5/32" (80mm)	19.0 oz. (540g)
55mm f/2.8	9 elements, 6 groups	65°	22	Automatic	1.75ft. or 0.55m	58mm	Screw-in	2-25/32" (71mm)	2-3/4" (70mm)	13.9 oz. (395g)
70mm f/2.8 (lens-shutter type)	6 elements, 4 groups	53°	22	Automatic	2.75ft. or 0.8m	58mm	Screw-in	1-31/32" (50mm)	3" (76mm)	13.9 oz. (395g)
80mm f/1.9	7 elements, 6 groups	47°	22	Automatic	2.25ft. or 0.7m	67mm	Screw-in	2-5/16" (59mm)	2-31/32" (75.5mm)	14.8 oz. (420g)
80mm f/2.8	6 elements, 5 groups	47°	22	Automatic	2.25ft. or 0.7m	58mm	Screw-in	1-27/32" (47mm)	2-3/4" (70mm)	8.8 oz. (250g)
Macro 80mm f/4	6 elements, 4 groups	47°	22	Automatic	1.25ft. or 0.375m	67mm	None required	2-15/16" (75mm)	3-1/8" (79mm)	20.6 oz. (585g)
110mm f/2.8	5 elements, 5 groups	35°	22	Automatic	4ft. or 1.2m	58mm	Screw-in	2-3/8" (60mm)	2-3/4" (70mm)	13.8 oz. (390g)
150mm f/4	5 elements, 4 groups	26°	32	Automatic	5ft. or 1.5m	58mm	Built-on	3-9/16" (90.5mm)	2-3/4" (70mm)	15.5 oz. (440g)
210mm f/4	5 elements, 4 groups	19°	32	Automatic	8ft. or 2.5m	58mm	Built-on	5-13/32" (137mm)	2-3/4" (70mm)	25.2 oz. (715g)
300mm f/5.6	6 elements, 5 groups	13°	32	Automatic	15ft. or 4m	58mm	Built-on	6-15/32" (164mm)	2-3/4" (70mm)	25.0 oz. (710g)
500mm f/5.6	6 elements, 5 groups	8°	45	Automatic	30ft. or 9m	105mm	Built-on	14-3/32" (358mm)	4-1/2" (114mm)	80.4 oz. (2280g)

61

Depth-of-Field Table

● 80mm f/1.9 and 80mm f/2.8

As each lens alters perspective, a choice of lenses offers you a choice in the manner of expression. Mamiya-Sekor C lenses are your tools for creative photography.

Because the Mamiya-Sekor C 35mm f/3.5 and 45mm f/2.8 lenses incorporate a Floating System in which some of the lens elements automatically move forward or backward as the lens is focused, high resolution, including the very edges of the field, is assured even at the minimum (closest) focusing distances.

The 70mm f/2.8 lens has a built-in between-the-lens shutter which makes it possible to synchronize electronic flash at all speeds up to 1/500 sec. (1/500—1/30 sec.). Moreover, the between-the-lens shutter of the lens can be by-passed at any time, allowing the focal plane shutter of the camera to be used in its place.

Aperture	Distance (feet)										
	∞	30	15	10	7	5	4	3.5	3	2.5	2.25
1.9	158' ∞	25' 4" 36' 10"	13' 9" 16' 6"	9' 5 1/2" 10' 7"	6' 9" 7' 3 1/2"	4' 10 1/2" 5' 1 1/2"	3' 11" 4' 1"	3' 5 1/2" 3' 6 1/2"	2' 11 1/2" 3' 1/2"	2' 5 3/4" 2' 6 1/4"	2' 2 3/4" 2' 3 1/4"
2	150' ∞	25' 1" 37' 3"	13' 8" 16' 7"	9' 5" 10' 8"	6' 8 1/2" 7' 3 1/2"	4' 10 1/4" 5' 1 1/2"	3' 11" 4' 1"	3' 5 1/4" 3' 6 1/4"	2' 11 1/2" 3' 1/2"	2' 5 3/4" 2' 6 1/4"	2' 2 3/4" 2' 3 1/4"
2.8	106' ∞	23' 6" 41' 5"	13' 3" 17' 4"	9' 2 1/2" 10' 11"	6' 7 1/2" 7' 5"	4' 9 3/4" 5' 2 1/2"	3' 10 1/2" 4' 1 1/2"	3' 5" 3' 7"	2' 11 1/4" 3' 1/4"	2' 5 1/2" 2' 6 1/4"	2' 2 3/4" 2' 3 1/4"
4	75' 3" ∞	21' 7" 49' 3"	12' 7" 18' 6"	8' 11" 11' 5"	6' 5 1/2" 7' 7 1/2"	4' 8 3/4" 5' 3 1/2"	3' 10" 4' 2 1/4"	3' 4 1/2" 3' 7 1/2"	2' 11" 3' 1"	2' 5 3/4" 2' 6 1/4"	2' 2 1/2" 2' 3 1/2"
5.6	53' 3" ∞	19' 5" 67' 2"	11' 10" 20' 6"	8' 6 1/2" 12' 1"	6' 3" 7' 11"	4' 7 1/2" 5' 5"	3' 9 1/4" 4' 3"	3' 4" 3' 8 1/4"	2' 10 1/2" 3' 1 1/2"	2' 5 1/2" 2' 6 1/4"	2' 2 1/4" 2' 3 1/4"
8	37' 9" ∞	16' 11" 139"	10' 11" 24' 3"	8' 1/2" 13' 3"	6' 0" 8' 5"	4' 6" 5' 7 1/2"	3' 8 1/4" 4' 4 1/2"	3' 3 1/4" 3' 9 1/4"	2' 10" 3' 2 1/4"	2' 4 3/4" 2' 7 1/2"	2' 2" 2' 4 1/4"
11	26' 9" ∞	14' 4" ∞	9' 9 1/2" 32' 8"	7' 5 1/2" 15' 5"	5' 8" 9' 2"	4' 3 3/4" 5' 11 1/2"	3' 6 3/4" 4' 6 3/4"	3' 2 1/4" 3' 10 3/4"	2' 9 1/4" 3' 3 1/4"	2' 4 3/4" 2' 8"	2' 1 3/4" 2' 4 3/4"
16	19' 0" ∞	11' 10" ∞	8' 7" 64' 10"	6' 9" 19' 11"	5' 3 1/2" 10' 6"	4' 1" 6' 5 1/2"	3' 5" 4' 10"	3' 1/4" 4' 1 1/4"	2' 8 1/4" 3' 5"	2' 3 1/2" 2' 9"	2' 1 1/4" 2' 5 1/4"
22	13' 6" ∞	9' 6" ∞	7' 3 1/2" ∞	5' 11 1/2" 34' 4"	4' 9 1/2" 13' 5"	3' 9 3/4" 7' 4 1/2"	3' 2 3/4" 5' 3 1/2"	2' 11" 4' 5"	2' 7" 3' 7 1/4"	2' 2 1/2" 2' 10 1/2"	2' 3/4" 2' 6 1/2"

Accessories

● Filters

Filters are available in 58, 67, 77, and 105mm sizes and come in the following five types: SY48 (Y2), SO56 (O2), SL39 (UV), YG, SL-1B (skylight). The correct filter sizes are indicated on pages 61 and 74.

● Lens Hoods

An important accessory to eliminate the detrimental effects of stray light entering the lens.

The lens hood for the 45mm wide-angle lens is square in shape and the same as the Mamiya RB67 65mm wide-angle lens hood.

Exclusive lens hoods are available for the 55mm, 70mm, and 80mm f/1.9 lenses. The 80mm f/2.8 and 110mm lenses share the same lens hood. Telephoto lenses are equipped with their own built-on lens hoods which should be fully extended when in use. The 35mm lens does not require a lens hood.

● Bellows Lens Hood

The length of the Bellows Lens Hood can be freely adjusted with the rack and pinion for use with any lens from 55mm to 300mm focal length. The RT-58 and RT-67 adapter rings are included for attachment to lenses with 58mm or 67mm diameter filter threads. A very useful feature of the Bellows Lens Hood is the gelatin filter slot directly in front of the lens which accepts standard 3 in. (7.6cm) gelatin filters. By combining the Bellows Lens Hood with the Auto Bellows and Slide Copy Attachment for the M645, any slide from 35mm to 6×7cm can be copied.

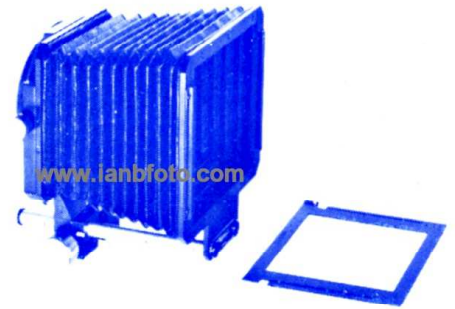

● Focusing Handle

The focusing handle is a grip that attaches to the focusing ring and makes rapid focusing possible. Ideal for sports, news, and action photography. This focusing handle can be used on all lenses from 55 to 300mm except the 70mm f/2.8 and 80mm f/1.9 lenses.



63

Accessories

● **Focusing Screens** Five interchangeable focusing screens are available to meet various photographic needs.

No.1 Microprism

Entirely matted, with a Fresnel lens and a central microprism spot. It is ideal for general purpose photography. The microprism assures rapid and accurate focusing and the matte surface makes the entire screen suitable for focusing.

No.2 Matte

All matte with Fresnel lens. Ideal for close-up photography, checking the depth-of-field, and slow lenses such as the 500mm f/5.6 since there is no microprism or rangefinder central spot. Focusing aids such as microprisms and rangefinders grow dark when the lens is stopped down and may prove distracting. The No.2 focusing screen is designed to eliminate this problem.

No.3 Checker

All matte with Fresnel lens and engraved lines. The engraved lines are a useful aid in determining composition. The intersections also prove useful as reference points when making multiple-exposures where perfect registration of the images is called for.

No.4 Rangefinder Spot

All matte, with Fresnel lens and central rangefinder spot. Assures accurate focus even with wide-angle lenses which are usually more difficult to focus because of the extensive depth-of-field. Also suitable for general purpose photography.

No.5 Rangefinder Spot 45°/Microprism

A highly versatile screen which offers three-way focusing for ultimate focusing accuracy. A central split-image rangefinder spot has a diagonal wedge (45°) which makes pinpoint focusing possible with either horizontal or vertical lines. A microprism collar surrounds the rangefinder spot, serving as a useful focusing aid with any subject. Finally, a fine ground glass ring encircles the microprism collar, for easier focusing even at relatively small apertures. The remainder of the screen is all matte and has a Fresnel lens for corner-to-corner brightness.

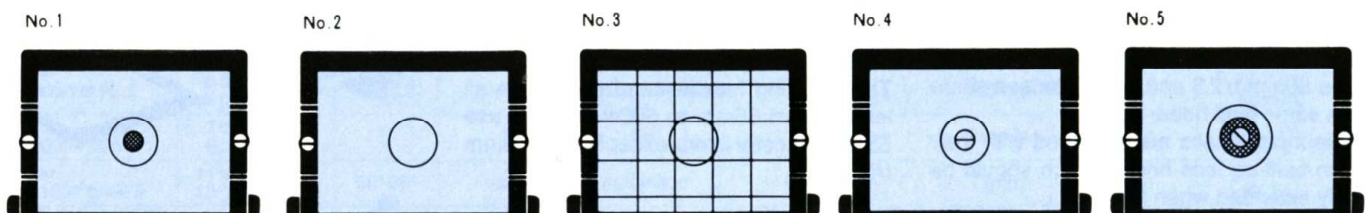

64

● **Magnifier**



For precise focusing. Magnifies the central portion of the focusing screen. Magnification of 2X and built-in -5 to +5 diopter correction.

● **Angle Finder Model 2**

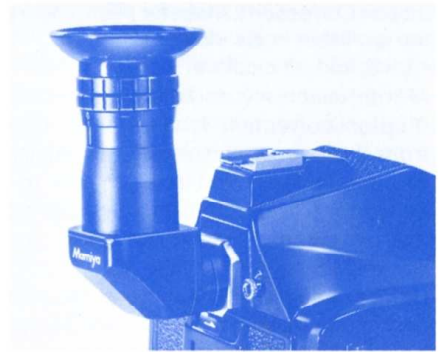

Useful for low angles and copy work. More versatile than waist-level finder because if the camera is held vertically, the image appears upside down in the waist-level finder, but rightside up in the angle finder. Thus visualizing composition is faster and easier. The angle finder has click stops and built-in diopter corrections of -4 to +4.

Accessories

● **Diopter Correction Lenses**

Diopter Correction Lenses for prism finders are available in six strengths: -3, -2, -1, +1, +2, and +3 diopters.

Merely unscrew (counterclockwise) the diopter correction lens retainer ring from the eyecup, insert the necessary correction lens, and replace the retainer ring. Then slide the eyecup on the eyepiece of the prism finder for easier focusing.

Before actually purchasing a Diopter Correction Lens at your Mamiya Dealer, be sure to attach it to the camera and try viewing through it to assure correct matching with your eyesight.



● **Diopter Lenses**

(Interchangeable diopter correction magnifiers)

For the waist-level finder. In addition to the standard -1.5 diopter magnifier, there are five more magnifiers available: -3, -2, 0, +1, +2 diopters. The method of changing magnifiers is explained on page 52.

● **Auto Bellows**

The Auto Bellows represents the ultimate tool for macrophotography. The special features of this high performance instrument are indicated below.

1. Accepts a double cable release for diaphragm automation.
2. Has shifts and tilts for depth-of-field and perspective control.
3. Has a revolving mount which makes it possible to instantly rotate the camera from horizontal to vertical format, or vice versa.
4. In addition to standard front focusing, the focusing rail allows moving the

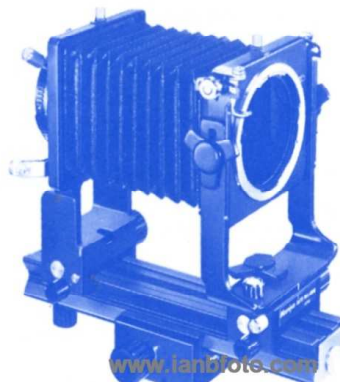

entire camera and bellows combination back and forth for fine focusing control.

● **Balloon Bellows**

The Balloon Bellows is available for easily making shifts and tilts which are difficult with the Auto Bellows at short extensions.

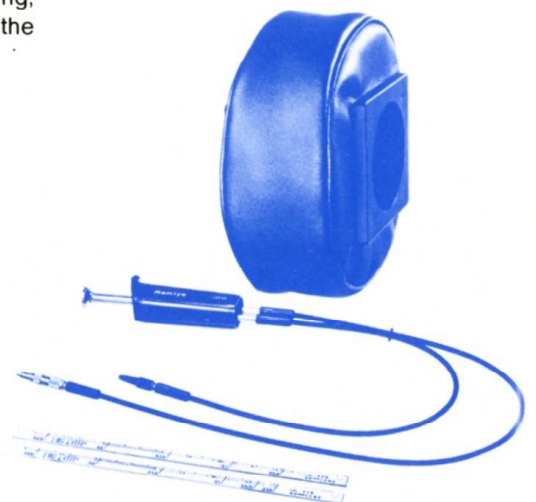

● **Reverse Rings RS-58, RS-67**

Reverse rings are used to mount the lens in reverse position for improved performance when photographing at larger than life-size. Reverse rings are available to fit either 58mm or 67mm diameter filter threads.



● **Connecting Rings CN-58, CN-67**

CN Rings are used to attach the Bellows Lens Hood when copying 35mm format slides. An RS Ring is essential to mount the lens in the reverse position, because the magnification ratio is larger than life-size. The CN Rings are available for 58mm and 67mm diameter filter threads.



● **Slide Copy Attachment Set**

Use in conjunction with the Auto Bellows and Bellows Lens Hood. The lens is first mounted on the Auto Bellows, and the Bellows Lens Hood is then attached to the lens. Finally, the Slide Copy Attachment is attached to the front of the Bellows Lens Hood, which then functions as a slide copier. Five sizes of slides can be copied: 35mm, 4×4, 6×4.5, 6×6 and 6×7. Film strips can also be copied.

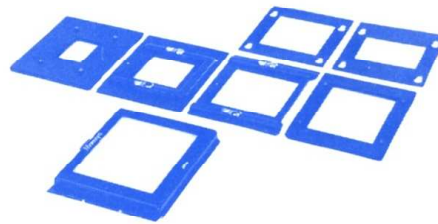

● **Auto Macro Spacer**

Used with the 80mm f/4 Macro Lens, this spacer allows close-up photography from one-half to life-size. Diaphragm automation and meter coupling make operation the same as for normal camera usage.



Accessories

● **Auto Extension Rings**

A set of three auto extension rings (designated No.1, No.2, No.3-S) are designed for use with the 80mm f/1.9 and 80mm f/2.8 lenses. Diaphragm automation and meter coupling are retained to simplify the exciting world of close-up photography. The following chart indicates magnification as well as the size of the subject it is possible to photograph.

Rings	Magnification	Subject size
No.1	0.15 – 0.30	11-1/8"×13" – 5-1/2"×7-1/4"
No.2	0.29 – 0.44	5-9/16"×7-1/2" – 3-11/16"×4-15/16"
No.3-S	0.44 – 0.59	3-11/16"×5" – 2-3/4"×3-3/4"
* No.1+No.3-S	0.59 – 0.74	2-3/4"×3-3/4" – 2-3/16"×3"
* No.2+No.3-S	0.74 – 0.89	2-3/16"×3" – 1-7/8"×2-1/2"
*No.1+No.2+No.3-S	0.88 – 1.03	1-7/8"×2-1/2" – 1-9/16"×2-1/8"

* When combinations of more than two auto extension rings are used with the f/1.9 lens, the No.3-S ring should be closest to the camera body. No.3 rings which do not have the designation, "S" were designed for the f/2.8 lens and should not be used with the f/1.9 lens as they may cause vignetting. When purchasing an auto extension ring for an f/1.9 lens, be sure the No.3 ring has the "S" designation.



● **Roll-Film Inserts**

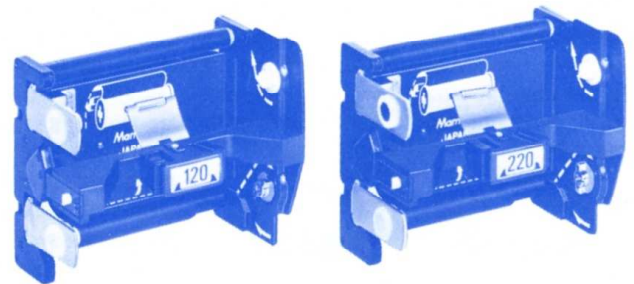

Roll-film inserts for 120 and 220 film are available. The inserts come in cases so that they can be safely stored. With several preloaded film inserts, it will be possible to change film almost instantly and to take a large number of photographs without wasting time loading film.

● **6 × 4.5 Slide Mounts**

Sets of 50 to a box are available.

Accessories

Useful for eliminating camera movement and convenient for carrying the camera, these grips make holding the camera vertically or horizontally comfortable.

● Pistol Grip



Attaches securely to the bottom of the camera and couples to the shutter release button.

● Deluxe L-Grip Holder



Deluxe grip which couples to the shutter release button. Optional accessory shoe unit has provision for bounce flash.

69

Accessories

● Grip Holder



Lightweight, compact unit. Complete with accessory shoe.

● Revolving Tripod Adapter

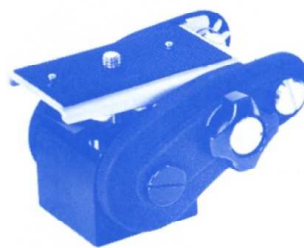

Allows instant change in format from horizontal to vertical, or vice versa, when working with the camera mounted on a tripod.

● Quick-shoe Model 2



A two piece set in which one piece is attached to the camera and the other to the tripod. When this is done, the camera can instantly be mounted to, or removed from, a tripod without the need to fumble with screws.

● Film Advance Crank



Interchangeable with the standard film advance knob, and an ideal choice for those who favor film advance crank.

70

● **Hand Strap**

Extremely convenient as it allows the camera to freely hang from the hand while carrying.



● **Compartment Case**

Large case which accepts camera mounted on hand grip, several lenses and accessories.



71

Accessories

● **Aluminum Custom Case**

A rugged, trunk-shaped case ideal for carrying, storing, or shipping your Mamiya M645 set. The sponge lining offers ample protection for your camera equipment.

Dimensions are 18-3/8"×13-7/8"×6-3/4" (47×35×17cm) and weight is 8 lbs. 2-1/2 oz. (3.7 kg).



72

Mamiya M645 System Chart

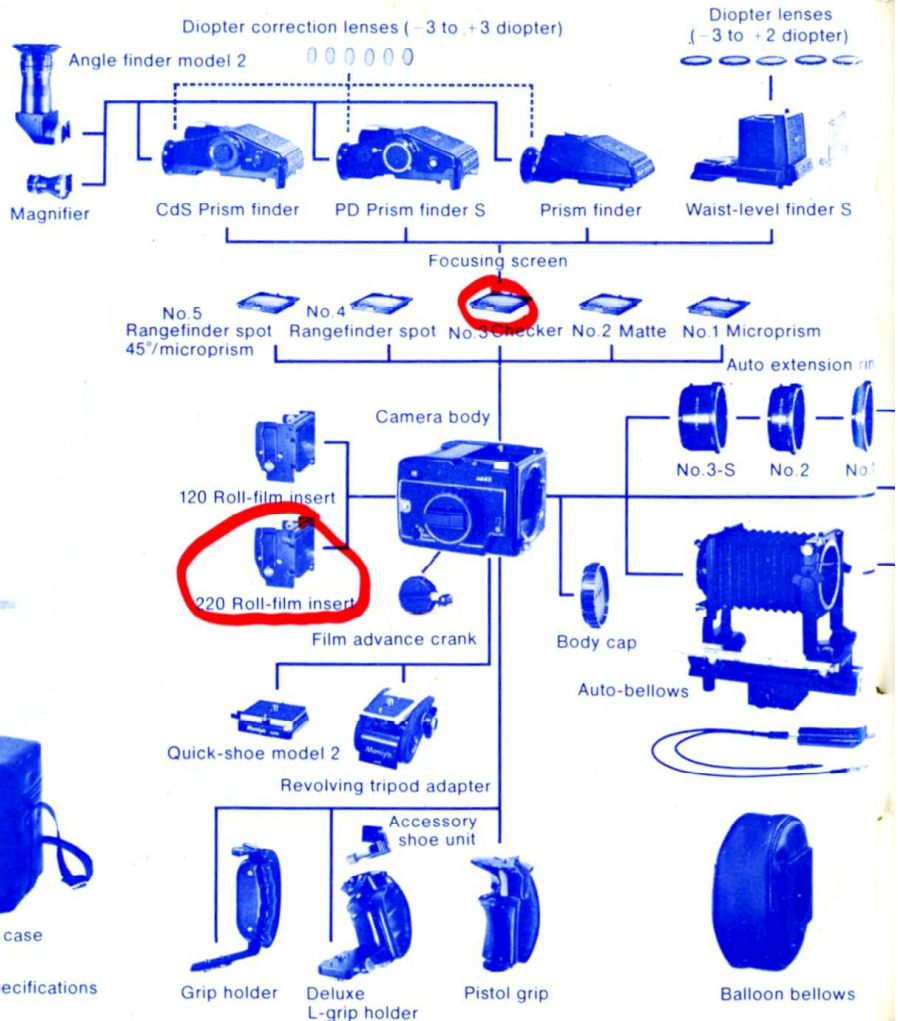

73

★ Due to a modification of the product, design and specifications are subject to change without notice.

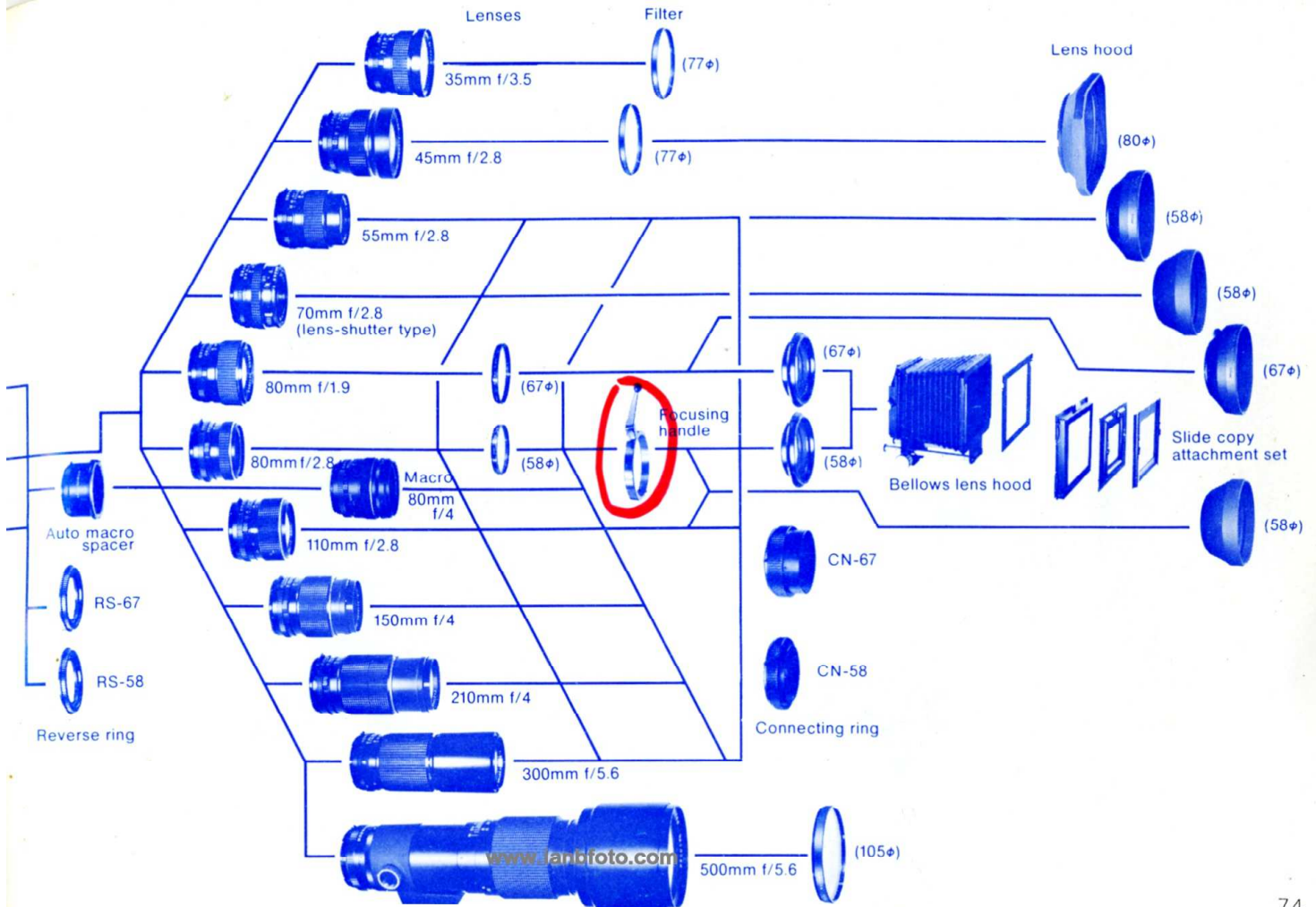



英改 SLS 30 78E 380

英語版
Printed in Japan