

M645 SUPER

ウエストレベルファインダーN Waist Level Finder N Faltlichtschacht N Viseur capuchon N

www.ianbfoto.com



日本語 使用説明書
English Instructions
Deutsch Bedienungsanleitung
Français Mode d'emploi



仕様外觀は品質向上のために予告なく変更する場合があります。
Specifications and appearance are subject to change without notice.
Änderungen im Sinne des technischen Fortschritts vorbehalten.
Ces caractéristiques sont susceptibles d'être modifiées sans préavis

Printed in Japan
Imprime au Japon

日本語

各部の名称

- ① ルーペ着脱指標
- ② フード起こしつまみ
- ③ ルーペ起こしボタン
- ④ ファインダー取り外しロック解除ボタン
- ⑤ 視野マスク
- ⑥ 視野わく (80mm用)
- ⑦ 取り付けつめ
- ⑧ 接眼わく
- ⑨ ファインダー取り外しボタン

English

Names of each part

- ① Alignment Dot for Changing Magnifier
- ② Finder Hood Opening Tongue
- ③ Magnifier Release
- ④ Finder Lock Button
- ⑤ Auxiliary Sport Finder Mask for 110, 150 & 210mm Lenses
- ⑥ Sports Finder Wire-Frame
- ⑦ Attaching Latches
- ⑧ Sports Finder Eyepiece
- ⑨ Finder Lock Release Button

www.ianbfoto.com

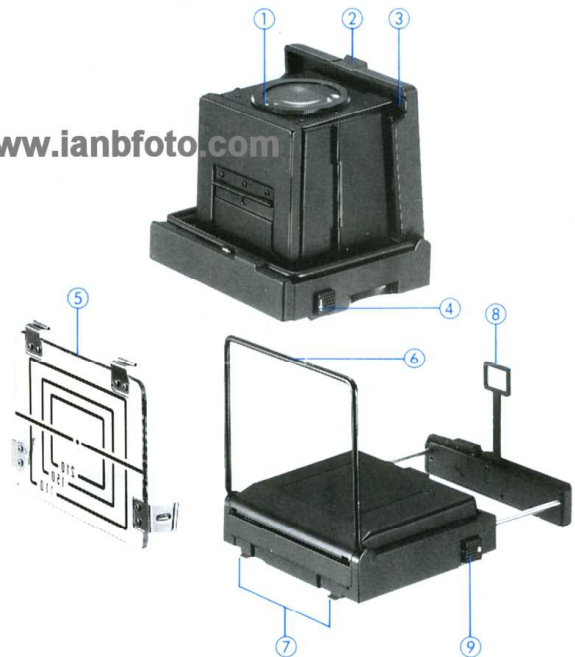

Deutsch

Teilebezeichnung

- ① Ansetzindex für Lupenwechsel
- ② Sucherschachtverriegelung
- ③ Lupenauslöser
- ④ Sucherverriegelungsknopf
- ⑤ Sportsuchermaske für Objektive mit 110, 150 und 210mm Brennweite.
- ⑥ Sportsucherrahmen
- ⑦ Befestigungsnasen
- ⑧ Sportsucherokular
- ⑨ Sucherentriegelungsknopf

Français

Description

- ① Index d'alignement pour changement de dioptrie
- ② Touche d'ouverture du viseur
- ③ Bouton de deverrouillage de la loupe
- ④ Bouton de verrouillage et de deverrouillage du viseur
- ⑤ Masque de visée sportive pour objectifs 110, 150 et 210mm
- ⑥ Support de masque de visée
- ⑦ Plots de fixation
- ⑧ Cadre de visée sportive
- ⑨ Verrouillage du viseur

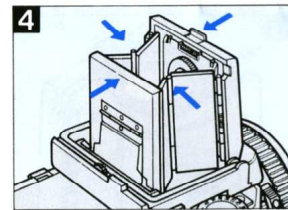
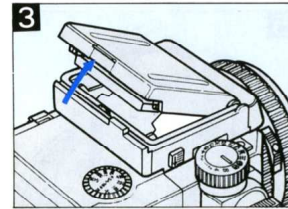
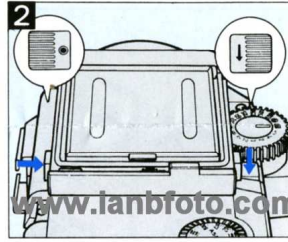
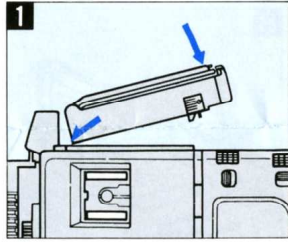

Features

The Waist Level Finder N is an easy-to-use enclosed type Finder Hood which can be opened and closed with a single touch. It is also equipped with a sports finder which can help you to capture the subject even when there is intense movement (ie. sports photography). The Diopter Lens is interchangeable, and five types are available as an optical accessory.

How to use Waist Level Finder N

Attaching the Finder

With the front of the finder slightly lowered, insert the Attaching Latches into the mounting groove of the camera body as illustrated. Push the rear of the finder until the rear hooks latch firmly. (Fig. 1)

Removing the Finder

Push the Finder Lock Release Button (©) while pushing down the Button (↓) at the opposite side and lift it up. (Fig. 2)

Raising the Hood

The Hood is Opened by raising the Finder Hood Opening Tongue. (Fig. 3)

Folding the Hood

After lowering the Magnifier, gently squeeze the right and left panels of the Hood together. Now release and the hood will close. (Fig. 4)

English

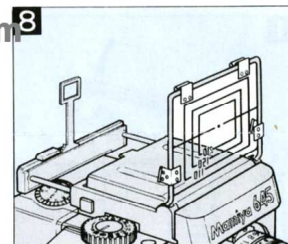
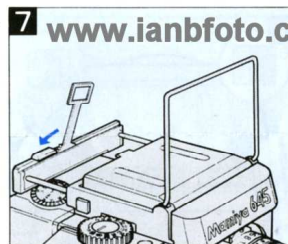
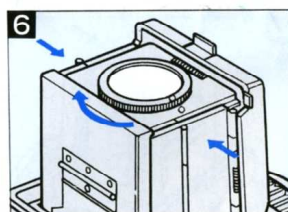
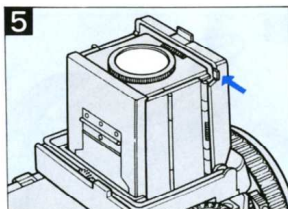

Raising and Lowering the Magnifier

To raise the magnifier, slide the Magnifier Release slightly to the left and the Magnifier will pop up into position.

To lower the magnifier, gently push the base plate of the Magnifier all the way down until it clicks in place. (Fig. 5)

Interchanging Magnifier

To remove the Magnifier, gently squeeze the sides of the Focusing Hood, preventing the Magnifier base plate from moving, rotate the Magnifier counterclockwise and remove. (Fig. 6)

Using the Sports Finder

With Waist Level Finder N in the closed position, first pull out part on which the Sports Finder Eyepiece is fixed until it stops.

Then, raise both the Sports Finder Wire-Frame and eyepiece to a vertical position.

The Sports Finder Eyepiece is raised by turning the gear knob in the direction of the arrow. (Fig. 7)

The Sports Finder Wire-Frame indicates the field for 80mm lenses.

When you want to use the 110, 150, or 210mm lens, the Auxiliary Mask must be attached to the Wire-Frame. (Fig. 8)

As the outside movement of photographing scene can be observed easily, the desired photographing is assured. It is recommended that you align the focus on the basis of the depth of field scale (and distance scale) of the lens, and that you set the smallest aperture possible.